

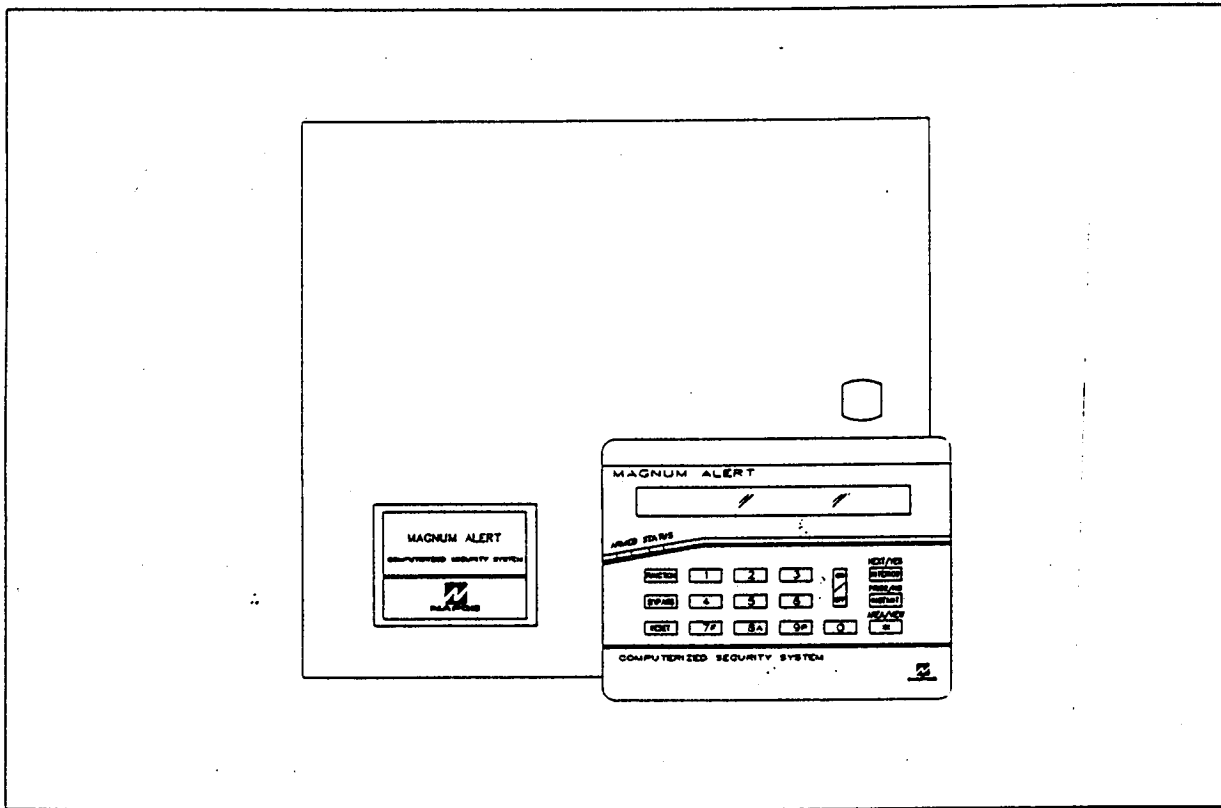

INSTALLATION INSTRUCTIONS

MAGNUM ALERT 3900 CONTROL PANEL/COMMUNICATOR



RP3003LCD & RP3005LCD KEYPAD INSTRUCTIONS INCLUDED.

Refer to accompanying MA3900 Programming Manual (WI777) for programming information.

NOTE: THESE INSTALLATION INSTRUCTIONS ARE INTENDED AND WRITTEN FOR THE PROFESSIONAL INSTALLER HAVING SUITABLE EXPERIENCE AND INSTALLATION EQUIPMENT. THE UNIT IS DESIGNED TO BE PROGRAMMED USING AN IBM-COMPATIBLE COMPUTER WITH NAPCO PCD3000 SOFTWARE. AFTER PROGRAMMING, BE SURE TO RUN THE PCD3000 ERROR-CHECK UTILITY TO GUARD AGAINST PROGRAMMING CONFLICTS FOR THE TYPE OF SERVICE SELECTED FOR THE INSTALLATION.

TABLE OF CONTENTS

<i>Section</i>	<i>Page</i>	<i>Section</i>	<i>Page</i>
1. INTRODUCTION	3	CONFIGURING THE KEYPADS	9
GENERAL DESCRIPTION	3	4. BASIC OPERATION	12
FEATURES	3	USER CODES & ZONE DESCRIPTIONS	12
SPECIFICATIONS	4	ARMING & DISARMING THE SYSTEM	13
ORDERING INFORMATION	4	BYPASSING ZONES	14
UL LISTINGS	4	ALARM INDICATION	14
COMPATIBLE UL-LISTED DEVICES	4	FUNCTIONS MODE	14
2. INSTALLATION	6	KEYPAD MESSAGES	17
MOUNTING	6	5. GLOSSARY	18
WIRING	6	6. APPENDIX	32
WIRELESS SYSTEMS	6	BATTERY CALCULATION WORKSHEET	32
TYPICAL RESIDENTIAL FIRE INSTALLATION	6	WIRING LEGEND	33
TYPICAL PARTITIONED INSTALLATION	7	KEYPAD FUNCTION & PROGRAM MODES	34
UL COMMERCIAL-BURG. INSTALLATIONS	7	FUNCTIONAL DIAGRAM, KEYPAD CONFIGURATION MODE	35
TESTING THE SYSTEM	8	WIRING DIAGRAM	36
3. KEYPAD CONFIGURATION	9		
PRELIMINARY INFORMATION	9		

Napco Security Systems, Inc.
333 Bayview Avenue, Amityville, New York 11701
For Sales and Repairs, call toll free: (800) 645-9445
For direct line to Technical Service, call toll free: (800) 645-9440

1. INTRODUCTION

GENERAL DESCRIPTION

The Magnum Alert 3900 Series are state-of-the-art microcomputer-based burglary and residential fire alarm control panels of modular design. Integrally 8-zone panels, they will support up to 96 zones with the use of optional zone expansion modules and/or RP3005LCD Keypads. Each panel includes an integral digital communicator.

The control panel features programmable area partitioning. That is, the system may be divided into up to eight discrete multiple-zone areas, each allowing access by only those users programmed for their respective area.

Opening Suppression and Closing Suppression, available through Napco Quickloader software, suppress reporting within programmed "windows". Conversely, Exception Reporting can transmit a "fail to close" if the panel is not armed within programmed intervals and, similarly, "fail to open" if the panel is not disarmed within programmed intervals. Furthermore, the panel can be programmed to automatically arm or disarm any area at any time. A log containing up to 800 events (accessible through Quickloader™ software or from the RP3005LCD keypad) monitors control-panel activity referenced to a precision real-time clock. A detailed event history may be displayed at the computer, with an abbreviated display available at the keypad.

Keypads feature a liquid-crystal display for English-language messages. In normal daily use, the LCD is used for zone identification and status messages. Conventional LEDs and a sounder are also provided for annunciation.

Data may be quickly and easily downloaded to the control panel using a PC-compatible computer with Napco's PCD3000 Quickloader software and PCI2000 computer interface. Or, the panel may be programmed in its secondary mode of operation by the keypad. In the programming modes (there are two: *Dealer* and *User*), the LCD shows memory address, data values, programming prompts, and the alphanumeric characters required for entering up to 96 user codes and custom zone descriptions.

Magnum Alert 3900M. The "Mercantile" version is supplied with a heavy-duty enclosure for increased tamper resistance and a tamper switch for tamper protection. (Note: Do not use Fire Zones in a Mercantile installation.)

Note: Failure to install and program as described in this manual for UL-listed systems voids the listing mark of Underwriters Laboratories, Inc.

FEATURES

Control Panel Features

- Eight end-of-line-resistor burglary zones programmable for Area, Exit/Entry Delay, Interior, Follower, Day Zone, Chime, Fire options, Sensor Watch, Swinger Shutdown, Zone *Arming* and a variety of other features.
- Supports up to 96 zones with optional zone-expansion modules and 4-zone keypads.
- Supports up to 96 individually coded users, each with a programmable authority level.

- Supports up to 96 relay outputs.
- Supports three keypad panics: Fire, Police & Auxiliary
- Supports up to eight independent area partitions.
- Supports up to eight separate access stations by up to 96 users.
- Supports up to 64 separately-addressable X-10 devices.
- English-language prompts & system status messages.
- User-customized zone descriptions, reprogrammable as required.
- Supports 2-wire and 4-wire smoke detectors.
- Reports alarms, restores and troubles by zone.
- 250 Event Schedule
- 800 Event Log.
- Overview Mode permits monitoring and control of total system.
- Guard-Tour programmable for start time, tour length, and check points.
- Two programmable entry delay times.
- Two Interior-Zone groups per area.
- Dynamic battery test interrupts charging and places battery under load every four hours.
- Chime by zone; programmable duration.
- Non-volatile RAM retains memory during power losses.
- All functions Quickloader programmable.
- Auto-Download Log.
- Exclusive *V.A.L.I.D.*™ feature (Verifying Automatic Line-Integrity Diagnostic) reduces false alarms due to changes in line resistance.

Communicator Features

- Compatible with all major receiver formats, including BFSK, 4/2, Modem 2, SIA, 4/3/1, 4 + 2 Express and Point ID.
- Rotary dial and TouchTone™ with Rotary backup.
- Three 20-digit telephone numbers.
- Backup Reporting; Double Reporting; Split Reporting.
- 96 User Codes with Opening/Closing Reporting by user.
- Ac Failure Reporting with programmable report delay.
- Supervised telephone line with programmable test times.
- Pager capability.

Keypad Features

- English-language LCD display; LED and sounder annunciators.
- Supports up to 15 4-wire keypads.
- Access only.
- Provisions for fire, police and auxiliary panic alarms.
- Integral 4-zone EZM included in each keypad (RP3005LCD only).
- Communicator Test to Central facilitates testing; Locate, Fault-Find and EZM-Locate diagnostics simplify troubleshooting.
- PGM output.

SPECIFICATIONS

MA3900

Operating Temperature: 0–49°C (32–120°F)
 Input Power: 16.5Vac via Class 2 Plug-In 50VA Transformer
 Panel Standby Current: 200mA
 Loop Voltage: 10–13Vdc
 Loop Current: 2.5mA with 2.2kΩ end-of-line resistor (Model EOL2.2K); 5mA for 2-wire smoke-detector zones
 Loop Resistance: 300Ω max.; 50Ω for 2-wire smoke-detector zones
 Relay Outputs (Burglary; Reset; Aux): Wet, 12Vdc, 1.2A max.; Dry (cut related jumper for dry contacts; see Wiring Diagram), SPDT contacts 24Vdc, 2A, 0.6 Power Factor
 Auxiliary Power Output: 12Vdc regulated
 Remote Power Output: 12Vdc regulated (for keypads)
 Combined Standby Current (Remote Power + Aux. Power + Reset Relay Power), Residential & Commercial Burglary (4 Hours Standby): See following chart.

	MA3900 STANDBY	MA3900 ALARM	PS3002 STANDBY	PS3002 ALARM
TRF12 (20VA) RBAT4 (1)	300mA	1.2A	–	–
TRF12 (20VA) PS3002 RBAT6 (1)	300mA	1.2A	415mA	1.485A
TRF12 (20VA) PS3002 RBAT6 (2)	300mA	1.2A	1.4A	0.5A
TRF11 (40VA) RBAT4 (1)	650mA	1.2A	–	–
TRF11 (40VA) RBAT6 (1)	650mA	1.2A	–	–
TRF11 (40VA) PS3002 RBAT6 (1)	650mA	1.2A	625mA*	1.275A*
TRF11 (40VA) PS3002 RBAT6 (2)	650mA	1.2A	1.4A*	0.5A*
TRF15 (50VA) RBAT6 (1)	700mA	1.2A	–	–
TRF15 (50VA) PS3002 RBAT6 (1)	700mA	1.2A	575mA*	1.225A*
TRF15 (50VA) PS3002 RBAT6 (2)	700mA	1.2A	1.4A*	0.5A*

*Alarm current from the PS3002 may be increased by reducing the standby current by the same amount.

EZM Module:

EZM3008: Input, 50mA (not including PGM output)
 PGM Output: 5mA, 12V Special Application

Keypad Current:

RP3005LCD: 100mA; 35mA if backlighting is disabled (cut W1, W2 & W3)

PGM Output: 5mA, 12V Special Application

Maximum Number of Keypads: 15

Maximum Wiring Length for each run (#22AWG): 1000' divided by total number of keypads and EZMs on run

Standby Time: Residential Fire/Burglary & Commercial

Burglary, 4 hours minimum; Commercial Fire, 24 hours
 Keypad Dimensions: 4³/₈" x 5⁷/₈" x 1¹/₁₆" (HWD); 11.1cm x 14.9cm x 2.7cm (HWD)

ORDERING INFORMATION

System Components

MA3900: Residential UL-Listed Burg and Fire Control Panel.

MA3900M: Mercantile UL-Listed Burg and Fire Control Panel.

RP3005LCD: 32-Character LCD Burg and Fire Keypad with 4 EOL Zones.

RP3003LCD: LCD Keypad.

Optional Accessories and Peripherals

EZM3004: 4-Zone Expansion Zone Module

EZM3008: 8-Zone Expansion Zone Module

RM3008: "Octal" Relay Module (in enclosure)

M278: Line-Reversal Module

PS3002: Power-Supply Module, 13.2Vdc, 1.9A

EOL130: 2-Wire Fire Zone Resistor, 130Ω, 3W

EOL2.2K: End-of-Line Resistor Assy., 2.2kW, for Fire Circuit

FT220K: End-of-Line Relay/Resistor Supervisory Module

RB1000: Relay Board*

RBAT4: Rechargeable Battery, 12Vdc, 4AH

RBAT6: Rechargeable Battery, 12Vdc, 6AH

RBATH1: Dual Battery Harness

RMX-10: X-10 Interface

RPB-3: Universal Junction Box

TRF11: Transformer, 16Vac/40VA, Class 2

TRF14: Transformer, 16Vac/50VA, Class 2

WL1: Wire Assembly with Lug Connector, 20"

MAV-15*: Two-Way Voice/Listen-In Module

PCD3000: Downloading Software for IBM PC-Compatible
 PCI2000/3000: Software with Interface for IBM PC-Compatible Computer

PCI-MINI: Notebook Computer Interface

W834-1: Keypad Cable, plug-in (20")

OI163: Instruction Manual, MA3900

OI192: Instruction Manual, RP3003LCD

OI193: Instruction Manual, RP3005LCD

WI777: Programming Manual

*Not tested by UL.

UL LISTINGS

Household Burglar Alarm System Units:

UL1023

Household Fire Warning System Units:

UL985

Local Burglar Alarm Units and Systems:

UL609

Central Station Burglar Alarm Units:

UL1610

Police Station Alarm Units:

UL365

CALIFORNIA STATE FIRE MARSHAL LISTING

Control Unit (Household):

COMPATIBLE UL-LISTED DEVICES

Refer to the following list of recommended devices.

Bells:

Ademco AD8-12; AD10-12

Amseco MBL-8/12V; MBL-10/12V
 Wheelock 46T-G4-12-R*; 46T-G6-12-R; 46T-G10-12-R
 Hochiki America AL-VB-1012*; AL-MB-612*

*Not for Household Fire applications (< 85dB at 10')

Grade-A Bell:

Ademco AB-12 Bell in Box

Horns:

Wheelock 34T-12-R; MT-12/24; MT4-12/24; MIZ-12

Faraday 6120-0-0-12-DC*

Federal Signal 450E-24

Hochiki America AL-FH-12M*

*Not for Household Fire applications (< 85dB at 10')

Mini-Horn

Federal Signal 460-024-R (red); -W (white); -BG (beige)

Chimes

Wheelock CH-CF1-12; CH-DF1-12 (both for private-mode signalling only)

Strobes

System Sensor SS1215ADA; SS1215ADAB

Wheelock LS12

Strobe/Horns:

Wheelock 7002T-12-W-FR; 7001T-12-W-FR; V7001T-12-W-FR

Gentex SHG-12H

System Sensor MASS1215ADA; MASS1215ADAB

Electronic Signals:

Wheelock ES-BH2-R; ES-DL2-R; ES-EL2-R

Electronic Signal/Strobes:

Wheelock ES-BH2-WH-12DC-HF-R; ES-DL2-WS-12DC-VF-R; ES-EL2-WS-12DC-HF-R

Bell/Strobes:

Wheelock 46T-G6-12-WS-12-HF-R; 46T-G10-12-WS-12-HF-R

Smoke Detectors, 2-Wire:

System Sensor 1400; 2400; 2400TH, each with self-contained base; 1451; 2451; 2451TH, each with B401B Base

Voltage Rating: 8.5-13.3Vdc

Maximum Number of Detectors: 10

Smoke Detectors, 4-Wire:

ESL 445AT, 445C, 445CT, 445CR, 445CRT

Gentex 812, 812T, 812P, 812PT, 812PH; 8120, 8120T, 8120P, 8120PT, 8120PH

Hochiki America SLG-12 with YBC-RL4-RA Base

System Sensor 2312/24T; 1412; 1412TH; 2412TH

Subtract total smoke-detector alarm current from available standby current.

Note: Any normally-open devices that do not require power from the control panel, such as pull stations, waterflow and thermostats may be used if acceptable to the Authority Having Jurisdiction.

INTERFACING THE VERSUS® STU-2Z TO THE MA3900

The STU-2Z may only be used in conjunction with telephone systems that support the VerSuS Derived-Channel Multiplex (DCX) Network.

*Cut Jumper "A" for dry normally-open contacts.

The STU-2Z is cross listed with these control panels as an accessory for Grade AA Central Station Burglar Alarm. For UL Grade AA, the following conditions must be met:

- The control must be installed and programmed to meet Grade-A burglary alarm system requirements.
- The control must be programmed for reporting all alarm conditions through the integral DACT to the same central station that monitors the STU-2Z.
- The STU-2Z must be mounted inside the control housing and connected as per the wiring diagram below.
- Once installed, the central station must enable 2-minute off-hook polling.

Supplementary Reporting

(For Commercial Burglar-Alarm Applications.) The two STU-2Z zones may be used for supplementary reporting by meeting the following requirements.

- Program the Aux. Relay* or any RB3008 Remote Relay for all alarm conditions that are required to report alarm on Zone 1 of the STU-2Z.
- Program the Aux. Relay* or any RB3008 Remote Relay for all alarm conditions that are required to report trouble on Zone 2 of the STU-2Z.
- Wire the normally-open terminals of the relay programmed to activate Zone 1 of the STU-2Z to Terminal 1 of the STU-2Z.
- Wire the common terminals of the relay programmed to activate Zone 1 of the STU-2Z to Terminal 2 of the STU-2Z.
- Wire the normally-open terminals of the relay programmed to activate Zone 2 of the STU-2Z to Terminal 2 of the STU-2Z.
- Wire the common terminals of the relay programmed to activate Zone 2 of the STU-2Z to Terminal 3 of the STU-2Z.

Installing the STU-2Z into the Control Housing

The STU-2Z PC Board Assembly is supplied with an attached metal mounting frame for installation inside the control housing. Wire the STU-2Z power wires and telco cables to the panel terminals and RJ31X as shown in the wiring diagram below.

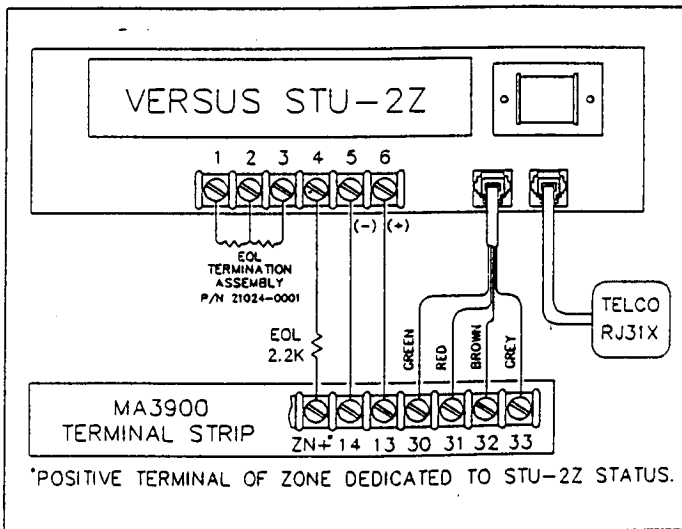

STU-2Z Wiring Diagram.

2. INSTALLATION

Note: This equipment generates and uses radio-frequency energy. If not installed using conventional installation practices for rf devices, it may cause interference to radio and television reception. It has been tested and found to comply with the limits for a Class A computing device pursuant to Subpart B of Part 15 of FCC Rules, which are designed to provide reasonable protection against such interference. However, there is no guarantee that interference will not occur in a particular installation. If it has been found to cause interference to radio or television reception, which can be determined by removing and reapplying ac and battery power to the equipment, the installer should try to correct the interference by one or more of the following measures: reorient the receiving antenna; connect the power transformer to a different outlet so that the control panel and receiver are on different branch circuits; relocate the control panel with respect to the receiver.

MOUNTING

Control Panel

Choose a mounting location accessible to (a) a continuously-powered ac source, (b) a cold-water-pipe ground ideally no further away than 10 feet, and (c) telephone lines (keep telephone wiring away from keypad wires). Remove appropriate knockouts for cables. Place the control panel at a convenient viewing height and mark the mounting holes. Attach the enclosure using screws suitable for the mounting surface.

Grounding. Connect the control-panel grounding screw to a metal cold-water pipe. Do not use a gas pipe, plastic pipe or ac ground connections. Use at least 16-gauge wire. Make the run as short and direct as possible, without any sharp bends in the wire.

Tamper Switches. Tamper switches may be installed to prevent opening of the control-panel door or removal of the cabinet from the wall. Ideally, tamper switches should be connected to a zone that is active at all times, thus it may be necessary to program that zone as a 24-Hour Zone or Day Zone. When used on a normally-open zone, normally-closed tamper switches (open when set) should be wired in parallel. On a normally-closed zone, install Napco TPS-2 normally-open tamper switches (closed when set) in series.

There are two places in the cabinet to mount tamper switches: (1) To prevent cabinet removal from the wall, there are three mounting holes on the left side of the cabinet, another hole on the back that allows the switch button to contact the wall. (2) To prevent opening the cabinet door, there are three mounting holes on the right side of the cabinet. When mounted, the switch button should contact the inside of the door. Be sure to alert the user that opening the enclosure door will cause a tamper alarm. **Note:** Each tamper switch is furnished with three machine screws for mounting, and one self-tapping screw. The sole purpose of the self-tapping screw is to tap the holes for the machine screws; it may be discarded after use.

Keypad

A keypad should be located near each exit/entry door. The keypad features a handy pull-up reference label. Before mounting the keypad onto the wall, push the Sliding Label Plate (with label and felt backing affixed and handle facing

forward) down the guides at the rear of the keypad until it snaps into place. Once installed, the Sliding Label Plate cannot be removed without first removing the keypad from the wall. **Note:** (1) The keypad fire and panic keys should not be considered a substitute for a listed manual initiating device, such as a pull box. (2) Each RP3005LCD includes provisions for four additional zones. See *ADDING EXPANSION ZONES*.

If installing onto a double-gang box, insert mounting screws through the two vertical elongated holes on the left side of the case and into the box. If the box is visible when viewed from the front, adjust the keypad vertically and tighten the screws. Then, using hardware suitable for the mounting surface, add one or two screws at the right side of the keypad case directly into the wall to ensure a secure installation. **Note:** Do not overtighten the screws! Uneven walls may cause the keypad case to distort.

WIRING

Wire keypad(s), zones, expansion zone modules and output devices as shown on the Wiring Diagram. Note that the Wiring Diagram contains important information not available elsewhere in this manual. **Caution:** Do not run telephone wiring near speaker wires; do not run keypad wiring with loop wiring.

Adding Expansion Zones

MA3900-Series control panels will handle up to 8 zones, however this number may be increased to up to 96 programmable zones using optional expansion zone modules (EZMs). Two models are available: the EZM3004 and EZM3008 provide 4 and 8 additional zones, respectively. (Refer to the instructions furnished with the EZM modules for expansion-zone wiring and system connection to panel.) Furthermore, each RP3005LCD can provide up to four additional zones and, in that regard, should be treated as a four-zone expansion module for the purposes of designing and configuring the system.

Note: Subtract total EZM current, as well as keypad current, from available standby current. Refer to *Ordering Information: Optional Accessories and Peripherals* for available power transformers.

WIRELESS SYSTEMS

With the addition of at least one R3000 receiver, the MA3900 will support up to 96 wireless transmitters. The panel can accommodate up to four receivers throughout the premises, responding to the one with the strongest transmitter signal. If any transmitters are selected for the default program, at least one R3000 receiver (RF EZM) will be programmed.

The keypad can display the status of any transmitter, indicating the condition of the zone (normal or open) and transmitter troubles (low battery, tamper or supervisory failure), and signal strength of the last transmission. A receiver failure will be indicated by "NO RES RF EZM X" ("no response", followed by the receiver number).

TYPICAL RESIDENTIAL FIRE INSTALLATION (Where permitted by local codes)

At least one smoke detector should be installed directly outside each sleeping area. If there is more than one floor, additional smoke detectors should be installed on each

level, including the basement. The living-area and basement smoke detectors should be installed near the stairway of the next upper level.

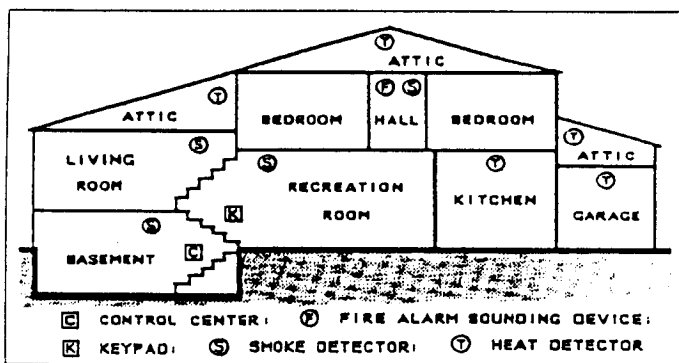

Typical fire installation.

For increased protection, additional detectors should be installed in areas other than those required, such as the dining room, bedrooms, utility room, furnace room, and hallways. Heat detectors, rather than smoke detectors, are recommended in kitchens, attics, and garages due to conditions that may result in false alarms and improper operation. Large areas and areas with partitions, ceiling beams, doorways, and open joists will require additional detectors.

Refer to NFPA Standard No. 74 (National Fire Protection Association, Batterymarch Park, Quincy, MA 02269) for additional information, including proper mounting of detectors.

TYPICAL PARTITIONED INSTALLATION

Described and illustrated here are an example of a partitioned system with common-area protection of the control-panel room. This system meets UL requirements for a partitioned installation.

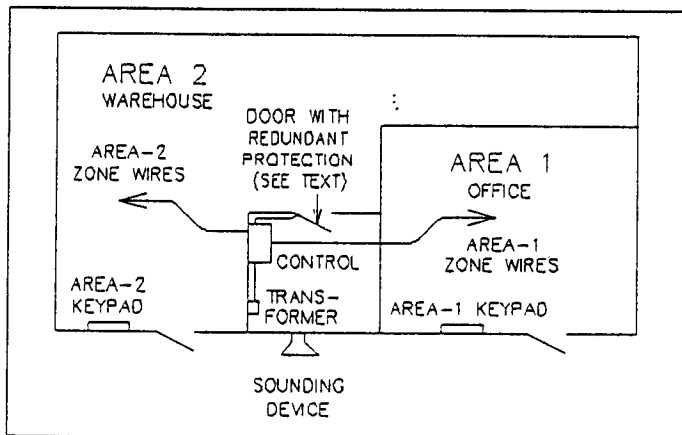

Typical partitioned installation.

- All areas must be owned and managed by the same person(s).
- All areas must be part of one building at one street address.
- The control panel and all wiring protecting each partitioned area must be confined to the respective area and may not encroach upon any other area. This requires that the control panel room have redundant protection; that is (a) multiple sets of door contacts, each wired to a separate zone and (b) one of those zones programmed for each area. In order to gain access to this protected

area without causing an alarm, all partitions must be disarmed. In lieu of redundant protection, 24-Hour Zones may be used. Any zone protecting the control panel and transformer may not be programmed for bypass.

- The sounding device must be placed such that the bell test can be heard by all partitions. **Note:** NFPA 74 (Household Fire Warning Equipment) requires that a fire alarm audible device be installed indoors.
- The User Program Code is not to be given to anyone except the authority responsible for all partitions.

UL COMMERCIAL-BURGLARY INSTALLATIONS

The MA3900 can be used as part of a UL Central Station Grade C, B, or A installation. Normally, a digital communicator is classified as Grade C and may be classified Grade B if used with the specified Grade-A Local bell and bell housing. A UL Central Station Grade-A installation requires the use of a Napco RB3008 Relay Board and Ademco 7720 Radio System. Refer to the installation instructions furnished with each component for respective installation requirements.

For a UL Commercial Grade-A Police Station Connection, refer to *GRADE-A LOCAL MERCANTILE INSTALLATIONS*, which follows. Use the M278 Line-Reversal Monitor to provide basic line security; refer to the instructions accompanying the M278 for other installation requirements.

Grade-A Local Mercantile Installations

A Grade-A Local Mercantile installation must use at least a 6.0AH standby battery. Programming must include *Auto Bell Test on Arming*. *Trouble on Night Open* may not be programmed.

The minimum requirements for a listed Grade-A Local system include:

- Low-Battery Annunciation.
- An Ademco AB-12 Bell and Box (12-volt).
- Program *Auto Bell Test on Arming*.
- a maximum Entrance and Exit Delay of 60 seconds.

Interfacing to the Ademco 7720 Long-Range Wireless System

The RM3008 may be used to interface the MA3900 control panel to the Ademco 7720 transmitter in order to meet UL Central Station Grade-A or Grade-B requirements by using a digital communicator combined with one-way wireless. (Normally, a digital communicator is Grade C, and may be Grade B if the specified Grade-A local bell is used.) Refer to the wiring diagram which follows, and to the instructions furnished with the Napco and Ademco equipment for further information concerning the DACT, listed compatible receiver and formats, Grade-A local bell and bell housing. *Enable Line Fault Test* must be programmed.

Central Station Grade-B Requirements.

Wiring to the Ademco 7720 transmitter must be enclosed in rigid conduit when outside walls, or in flexible conduit when inside walls or above ceilings, for the entire length up to the transmitter room. The transmitter room must be protected by a UL listed intrusion detection unit that is connected to one of the input channels of the Ademco 7720. Relays must be programmed to trip the Ademco 7720 for alarms on all protective circuits, including tampers, telco phone failure, 24-hour test timer, transmitter low battery and ac loss. (See PCD3000 Remote Relay Control screen.) One zone on the MA3900, programmed as a 24-Hour Zone,

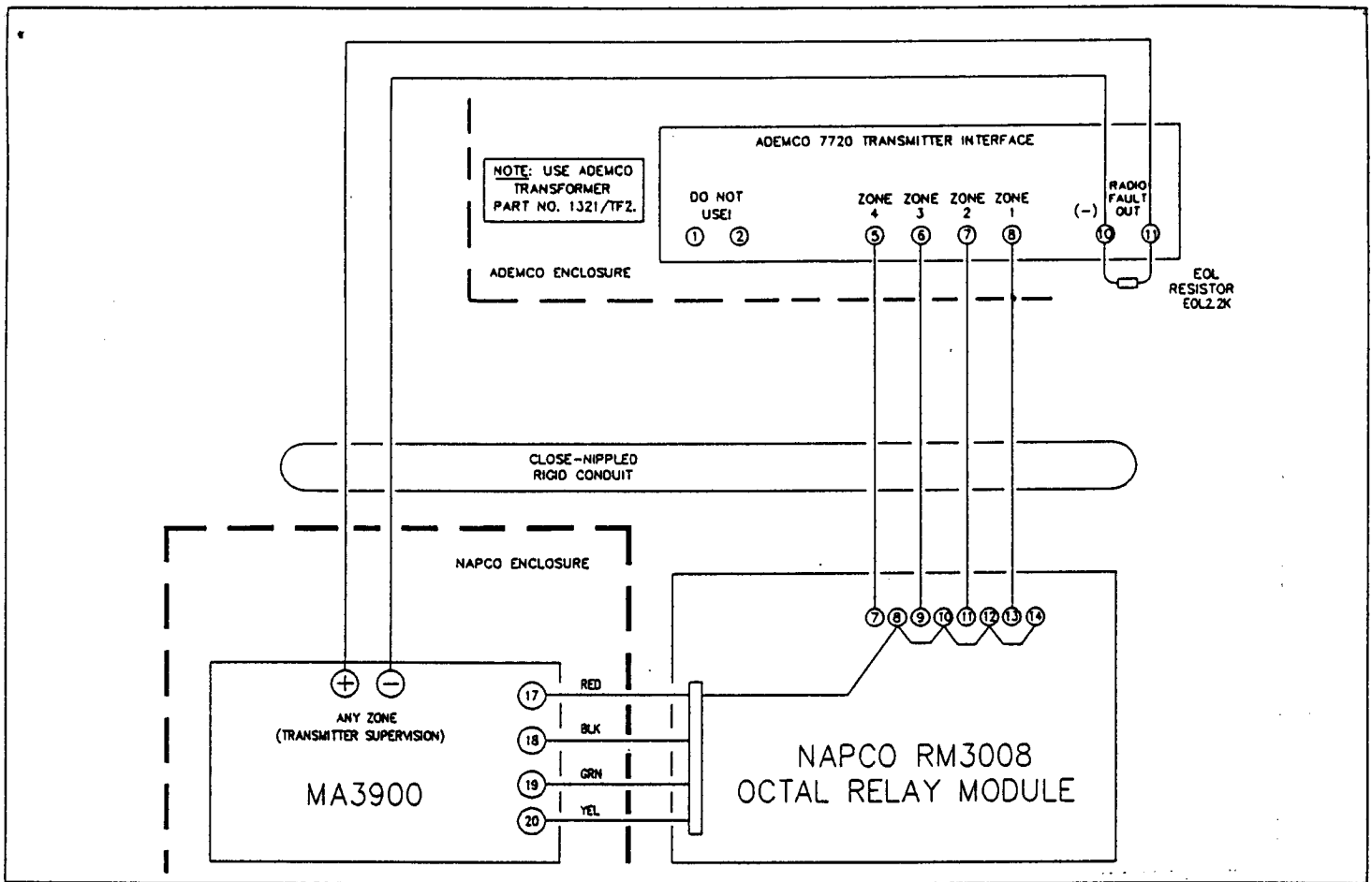

Interfacing to the Ademco 7720 Long-Range Wireless System.

must supervise the radio.

Central Station Grade-A Requirements.

In addition to Grade-B Requirements (above), one relay on the RM3008 must be programmed to trip the Ademco 7720 when the telephone line fails. Daily openings and closings are required to be transmitted by the Napco panel along with the 24-hour DACT test signal and DACT trouble conditions.

TESTING THE SYSTEM

After installation is completed, test the system as follows. Call the central station to inform them of the test. Initiate an alarm (preferably on a zone that activates a steady siren) and verify proper signalling. Then, call the central station to confirm their receipt of a good transmission.

Be sure to test all enabled keypad panics.

3. KEYPAD CONFIGURATION

This section will focus on configuring the RP3005LCD and RP3003LCD Keypads. References are made to keypad programming, which is covered in detail in the Programming Manual, WI777. (If there is more than one keypad in the system, only Keypad No. 1 may be used for programming.)

PRELIMINARY INFORMATION

Throughout this text, panel markings will be shown in upper-case letters (e.g., NEXT Button); button markings will be shown in bracketed upper-case letters (e.g., [INTERIOR] Button); LCD displays will be shown in quotes, in upper-case letters (e.g., "SYSTEM READY"). Refer to Programming Manual WI777 (supplied) for all programming information.

KEYPAD INSTALLATION

Two types of keypads may be used with the MA3900: the RP3005LCD and the RP3003LCD. Each must be assigned an address number (1–15 for the RP3005LCD; 1–7 for the RP3003LCD) and each requires its own configuration procedure (see *CONFIGURING THE KEYPADS*, which follows, and *Programming Manual WI777: KEYPAD AREA ASSIGNMENTS*). At least 1 keypad must be used; only 1 is required for a single-area Commercial Burglary installation.

RP3005LCD. The RP3005LCD is a 2-line combination fire/burglary/access keypad capable of supporting 4 EZM zones and a PGM output. An RP3005LCD is recommended for use as Keypad #1.

RP3003LCD. The RP3003LCD is a utility LCD keypad combining several preset LCD words with a limited message line.
Note: Due to space constraints, available messages are abbreviated and will scroll automatically.

CONFIGURING THE KEYPADS

A total of up to 15 keypads may be connected to the panel. RP3005LCD and RP3003LCD keypads may be intermixed but require different configuration procedures, as described in the following paragraphs. (Note that RP3003LCD keypads are limited to #1–7.)

Configuring the RP3005LCD Keypad

Each RP3005LCD keypad must be configured for (a) keypad tactile beep; (b) entry sounder; (c) keypad address; (d) compatibility number; (e) EZM address; and (f) zone response.

To enter the RP3005LCD Configuration Mode,

1. Move Jumper JP5 (located at the upper-right corner of the board) from Pins 1-2 (top two) to Pins 2-3 (bottom two).
2. After about 15 seconds, the display will read "XX OUT OF SYSTEM".
3. Press [1], [1], [1], [2], [3], [FUNCTION] and proceed as follows. (Repeat the following procedure for all keypads.)

Keypad Tactile Beep

Upon entering the Keypad Configuration Mode, "Keypad Beep ON" will be displayed, indicating that the tactile beep, which sounds when any button is pressed, is on. To turn off the tactile beep, press the [ON/OFF] Button (the [ON/OFF] Button will toggle the tactile beep on and off). Press the [FUNCTION] Button to continue or press [RESET] to exit.

Keypad Beep	ON
-------------	----

Entry Sounder

To turn off the keypad sounder during entry time, press the [ON/OFF] Button (the [ON/OFF] Button will toggle the entry sounder on and off). Press the [FUNCTION] Button to continue or press [RESET] to exit.

Entry Sounder	ON
---------------	----

Keypad Address

If more than one keypad is installed,

- each must be assigned a unique keypad address (that is, no two keypads may be numbered alike);
- keypads must be numbered consecutively (missing numbers are not permitted); and
- only Keypad No. 1 may be used for programming.

To assign the keypad number, proceed as follows:

1. Press the [FUNCTION] Button until "KP Address XX" is displayed.
2. Enter the assigned keypad number 01–15, then press the [ON/OFF] Button to save. A valid number will be acknowledged by a short beep; an invalid number will be rejected by a long beep.

Note: In multiple-keypad/multiple-area configurations, each keypad must be designated to an area. See *Keypad Area Assignments* in the Programming Manual.

3. Press the [FUNCTION] Button to continue or press [RESET] to exit.

KP Address	01
------------	----

New Compat# 0000

Compatibility Number

The compatibility number is a 4-digit security code that, if programmed into both the control panel and each RP3005LCD keypad, dedicates the keypad to only that panel. That is, (a) similar keypads not having the correct compatibility number will not operate in the system and (b) a keypad may not be removed for use on a system with a different compatibility number. **Note:** (1) If assigning compatibility numbers, record and store them in a safe place. (2) The RP3003LCD Keypad will function with or without a Compatibility Number.

While the compatibility number may be changed, the old number must be known in order to program the new number. **Note:** If neither the control panel nor the keypad is given a compatibility number, both default to "0000" (thereby maintaining compatibility).

To program the compatibility number, press the [FUNCTION] Button until "New Compat#0000" is displayed. Enter the 4-digit compatibility number that is programmed into the panel. **Note:** If the keypad had been previously programmed for a compatibility number other than "0000", the display would read "Old Compat.# xxxx". Enter the existing number before attempting to change it.

EZM Address

The keypad's internal EZM (Expansion Zone Module) may be utilized to provide four additional wired zones. Whether used alone or in conjunction with optional EZM3000-series modules or other keypad EZMs, it must be assigned a unique address (or *Group* number, see Keypad Programming Workbook) similar to its keypad address. If no other EZMs are to be used, designate the keypad as Group "01" at the "EZM Address 00" display. In multiple-EZM systems, enter an assigned group number "01" through "22". (Each EZM must have a unique assigned group number, starting with "01" and proceeding consecutively.)

EZM Address 01

Zone Response

The normal loop response time of each keypad expansion zone is 750mS. However, the response time of any zone can be reduced to 50mS as follows.

1. Of the following, circle the number(s) in parentheses associated with the zone(s) to be changed:

Zone 1 = (1)

Zone 2 = (2)

Zone 3 = (4)

Zone 4 = (8)

2. Add up the circled numbers.

3. At the keypad, enter the sum as a two-digit number "01" through "15" on the display, then press the [ON/OFF] Button.

Example. Change Zones 2, 3 and 4 to 50mS response.

1. Circle numbers for Zones 2, 3 and 4: (2), (4) and (8).

2. Add up the circled numbers: $2 + 4 + 8 = 14$.

3. Enter "14" at the keypad, then press the [ON/OFF] Button.

Press [RESET] to exit the Keypad Configuration Mode (display will read "01 OUT OF SYSTEM"). Then replace Jumper J5 across Pins 1-2 (top two pins).

Zn Response 00

Configuring the RP3003LCD Keypad

Up to 7 RP3003LCD keypads may be connected to the panel (Keypads 1–7). Each must be configured for (a) keypad address; (b) touchpad backlight; (c) LCD backlight; and (d) entry sounder. Keypads are configured by the proper selection of jumpers. Refer to the label on the circuit board fishpaper (LA1390) for jumper locations and a summary of settings.

KEYPAD NO.	ADDRESS JUMPER		
	1	2	3
1	ON	OFF	OFF
2	OFF	ON	OFF
3	ON	ON	OFF
4	OFF	OFF	ON
5	ON	OFF	ON
6	OFF	ON	ON
7	ON	ON	ON

Keypad address jumpers.

Keypad Address

If more than one keypad is installed,

- each must be assigned a unique address (that is, no two keypads may be numbered alike);
- keypads must be addressed consecutively (that is, missing numbers are not permitted); and
- only Keypad No. 1 may be used for programming. (However, for ease of programming, it is recommended that an RP3005LCD be selected as Keypad #1.)

Assign the keypad address number by selecting Jumpers J1–3 in accordance with the table at left.

Touchpad Backlight

Cut Jumper A to disable touchpad backlighting to conserve 11mA standby current.

LCD Backlight

Cut Jumper B to disable LCD backlighting.

Entry Sounder

Cut Jumper C to disable the sounder. (Do not disable in UL applications.)

4. BASIC OPERATION

This section provides a brief overview of system operation. For detailed operation, refer to the User's Guide furnished with the keypad (O1193 for the RP3005LCD; O1192 for the RP3003LCD). **Note:** Keypad displays shown in this text are for the RP3005LCD keypad. RP3003LCD displays will be similar, although abbreviated, and will scroll automatically.

USER CODES & ZONE DESCRIPTIONS

(Refer to the MA3900 Programming Instructions (WI777) for a detailed explanation of programming.) Up to 96 personal user codes may be programmed at the keypad. (The Authority Level and Access Byte associated with each User Code may only be programmed in the Dealer Program Mode.)

The first code programmed should replace the default (Level-3) code, "U01 123●●●-●●-●●" (1,2,3), which should not be selected as a user code. Enter up to six digits (a minimum of four digits is recommended). The related Option Code and Authority Level are programmable in the Dealer Program Mode only. **Note:** Do not attempt to enter any blank spaces in the code. When the code has been entered, press the SAVE Button ([ON/OFF]) to memorize it.

To advance to the next user code (or to any other user code, for that matter), position the cursor over the displayed User Number, i.e., "01" using the [FUNCTION] Button and enter a new User Number directly using the numerical keys. Similarly, enter a respective User Code directly using the numerical keys, then press the [ON/OFF] Button to memorize it. Advance to the next user code, as above, and repeat until all user codes have been programmed. **Note:** An attempt to program a code for Users 97-99 or 00 will result in the message "(ERROR-XX)".

Each user should be assigned his own dissimilar code and should be cautioned against divulging his code to anyone else. Thus should it become necessary to remove a user from the system, that one code may be cancelled without affecting other codes, and that user would then be prevented from entry. **Note:** Napco's PCD3000 Quick-loader Software provides enabling and disabling User Codes at programmed times using the scheduling menus.

Changing or Cancelling a Code. To change any code, merely program over the existing code as previously described, then press the SAVE Button ([ON/OFF]). Similarly, to cancel a code, blank out each number of the code using the CLEAR Button [0], then press the SAVE Button ([ON/OFF]).

Arm-Only Code (Programmable in Dealer Program Mode only). An Arm-Only Code, selected in conjunction with Authority Level, may only be used to arm the system; it never has any disarm capability. This may be programmed as a one- or two-digit code for the purposes of quick arming.

Service Code (Programmable in Dealer Program Mode only). The Service Code is an Arm/Disarm Code that is easily activated when needed, and dormant at other times. Intended for the occasional or temporary user (maid, repairman, etc.) who would otherwise be denied access to the premises, it is programmed in conjunction with the Authority Level when programming User Codes. Refer to MA3900 Programming Instructions and Workbook, WI777.

The Service Code is activated by arming with it; an "s" will

appear in the display (RP3005LCD only) after the exit-delay countdown, indicating that the Service Code has been activated. It may then be used to arm and disarm just as any other User Code. However it will automatically be deactivated the next time any other User Code is entered to arm the system, and it will remain deactivated until it is once again used to arm. Thus, the Service Code can always arm the system, but can only disarm if activated.

Panel Access Code. The Panel Access Code will trip the panel's Auxiliary Relay while disarmed if Access Control on Auxiliary Relay is programmed. The Panel Access Code is programmed as any other User Code but without an accompanying Priority Level. **Caution:** Do not use the same code as any Arm/Disarm Code. **Note:** These systems have not been investigated by UL for compliance with UL294 (Access Control Systems).

Keypad Access Code (Programmable in Dealer Program Mode only). Any of the 96 User Codes may be converted to a Keypad Access Code by programming the code's Access Byte (the last two digits of the code). Program the Access Byte for the applicable keypads 1 through 8, as indicated in the supplied Programming Workbook. Note that if the Access Byte is programmed, that User Code will function only as a Remote Access Code (not as an Arm/Disarm Code). Entering the code will cause a 5-second output on the PGM line with a pulsing sounder at the keypad and "--ENTER NOW--" displayed. **Note:** (1) Keypads may be programmed for access only, eliminating their arm/disarm function (keypad will then normally display "--ENTER CODE--"). (2) Keypad access may be logged into the event log by keypad.

Ambush Code. The Ambush Code is a two-digit code entered by the user just prior to disarming, typically to cause a silent report to be sent to the central station. Thus, should the user be forced to disarm by an assailant, he can silently signal an emergency while appearing to be merely disarming the panel. (Check the glossary for programming required to enable this feature.) Program the Ambush Code as any User Code.

Zone Descriptions. (RP3005LCD only.) Zone descriptions follow the Program Code in the normal programming sequence ("01-" will appear in the display). Program the description, up to two lines, letter by letter. Keys [1] and [2] control the position of the cursor. Key [0] will clear the entry at the cursor. When programming zone descriptions, Keys [3] and [6] will scroll not only through numbers 0-9, but through the alphabet and a series of punctuation marks and symbols as well. (Roughly note the order in which the letters, numbers and symbols are displayed so that you will be able to determine the proper direction to scroll, up or down, for fastest access. As familiarity improves, so will programming speed.) When the description has been entered and is satisfactory as displayed (e.g. "GARAGE"), press the SAVE Button ([ON/OFF]) to save it in memory.

To advance to the next zone (or to any other zone, for that matter), position the cursor over the displayed Zone Number, i.e., "01" using Keys [1] and [2] and change the Zone Number using Keys [3] and [6]. Repeat the zone-description programming procedure for the new zone. Advance to the next zone and repeat until all zones (up to 96) have been programmed.

ARMING AND DISARMING THE SYSTEM

In the normal disarmed state, only the green STATUS LED will be on and the display will read "SYSTEM READY". To silence an alarm, enter any User Code, then press the [ON/OFF] Button.

Any of the User Codes or the Service Code (if active) may be used to arm or disarm; an Arm-Only Code may only be used to arm.

Arming. To arm, enter the User Code, then press the [ON/OFF] Button. (If a wrong code is entered, the keypad will display "INVALID ENTRY / TRY AGAIN".) The green STATUS LED will go off, the red ARMED LED will go on, and the display will read "EXIT TIME XXX" ("XXX" representing the programmed exit-delay time, in seconds). The exit delay will immediately start counting down toward "000", in 10-second decrements, indicating the available time remaining to exit through an exit/entry door.

Note:

1. If *Exit Delay Restart* is enabled, after the panel is armed and the exit door is opened and then closed, exit delay will restart at 60 seconds. If re-entry occurs within this 60-second interval, the alarm device will sound a 2-second warning "chirp", if programmed, as an entry reminder to the user to return to the keypad and disarm.

2. (RP3005LCD only.) An "s" in the display (e.g. "EXIT TIME XXX S") will appear as a reminder that the system is being armed with the Service Code active. (To turn off the Service Code, disarm, then rearm using a regular Arm/Disarm Code.)

3. If a system trouble is displayed, correct the system trouble. Pressing [RESET] will permit arming within 5 minutes if repairs cannot be made immediately.

4. In commercial applications, if *Start Exit Delay After Ringback* is programmed, exit delay will not start until the central station acknowledges receipt by a ringback tone at the keypad. The display will read "PLEASE WAIT" while the control panel communicates to the central station. If the ringback tone does not sound within about 30 seconds, the *START EXIT TIME* function may be used to manually start exit delay.

Disarming. When the exit time has elapsed, the display will read "SYSTEM ARMED". This indicates that upon entering the premises through an exit/entry door, there will be an entry delay to allow time to disarm the panel. The RP3005LCD display will read "ENTRY TIME XXX" ("XXX" representing the programmed entry-delay time, in seconds). The sounder will come on and the entry delay will immediately start counting down toward "000" in intervals of 10 seconds, indicating the available time remaining to disarm the panel. The sounder will pulse during the final 10 seconds. To disarm the panel, enter a valid User Code, then press the [ON/OFF] Button.

Arming with No Delay. To cancel the entry delay on the Exit/Entry Zone, press the [INSTANT] Button prior to or after arming. The display will read "SYSTEM ARMED I" and the red LED will flicker. This feature may be used to provide instant protection while on the premises. It will be cancelled automatically upon disarming.

Priority Arming. A 2-second tone and "ZONE NOT NORMAL / CAN'T ARM" displayed when attempting to arm indicates a priority condition; that is, a problem exists on at least one zone that has been designated a *Priority Zone*, or a system

trouble exists. The trouble(s) must be corrected before the panel can be armed. The display will read "ZONE FAULTS", then automatically scroll through all unsecured zones. If a system trouble is indicated, display the system trouble.

Area Arming

In a partitioned system, any or all secured areas may be armed (or disarmed) simultaneously from either the Overview Mode or the Manager's Mode (if enabled). To arm or disarm any one area, see *Keypad Area Change*, which follows.

Overview Mode. (To enable or disable Overview, see *ACTIVATE OVERVIEW function later in this section*.) The Overview Mode is a high security mode of operation requiring a Level-3 User Code with Overview Option, wherein the status of all areas is displayed at the keypad. (Note: The RP3003LCD keypad will display the status of Areas 1 and 2 only.) When arming all areas, the "home" area remains disarmed. To arm any one area, see *Keypad Area Change*, which follows.

In the Overview Mode, "OV(---)" will be displayed, where each dash ("—") represents an area. In programmed areas, the dash will be replaced by one of the following:

"A" = Area Armed

"B" = Burglary Zone in Alarm

"C" = Check Trouble

"D" = Area in Function-Display Mode

"F" = Fire Area in Alarm

"N" = Normal Fire Area

"R" = Area Ready

"T" = Fire Area in Trouble

"Z" = Zone Fault

In the Overview Mode, all *ready* areas ("R") except the "home" area may be armed simultaneously by pressing [9], [*]. (Note: The User Code must be valid in all areas, otherwise only those areas recognizing the code will arm.) Similarly, all *armed* areas ("A") may be disarmed by entering [0], [*]. If any zone is not secured, the system will not arm and the keypad will display "CAN'T ARM SYSTEM / AREA # IN TROUBLE", where "#" represents the area number.

Manager's Mode. The Manager's Mode, in contrast to the Overview Mode, is a low-security mode of operation. Unlike the Overview Mode, when arming all areas (press [9], [*], [enter code]), the "home" area will also arm. As in Overview, if any zone is not secured, the system will not arm and the keypad will display "CAN'T ARM SYSTEM / AREA # IN TROUBLE", where "#" represents the area number. To disarm all areas, press [0], [*], then enter a valid code. To arm any one area, see *Keypad Area Change*.

Keypad Area Change. To arm or disarm any one area:

1. Enter the number representing the area to be selected.
2. Press the [*] Button, then the [ON/OFF] Button. The keypad will display "SYSTEM READY X", where "X" denotes the area selected.
3. Arm or disarm the area using your code (the code must be valid in that area).
4. To return the keypad to its "home" area, press the [*] Button, then the [ON/OFF] Button.

Note: If the "home" keypad has been changed to another area and unused for more than 5 minutes, it will revert to the home area.

BYPASSING ZONES (Also see *DISABLING FIRE ZONES*, which follows.)

Security Bypass

Zones programmed for *Selective Bypass* may be removed from the system prior to arming as follows:

1. Enter a code valid for bypass (Authority Level 1 or higher and *Bypass* option enabled), then press the [BYPASS] Button; "BYPASS ENABLED" will display.
2. Press the [BYPASS] then the zone number (or vice versa) to deactivate that zone.

Note: When the panel is subsequently disarmed, all bypassed zones revert to unbypassed zones (unless *Disable Auto Unbypass* is programmed or Interior-1 Zones are programmed normally bypassed).

Function Mode Bypass

In the Function Mode, either of the following two methods may also be used to bypass zones.

A. From the "DISPLAY STATUS" Screen,

1. Enter code valid for bypass, then press the [FUNCTION] Button. "DISPLAY STATUS" will appear.
2. Press [ON/OFF] to display status. The number of faulted zones will display briefly, followed by the first faulted zone.
3. Press the [BYPASS] Button to bypass the zone.
4. Press the NEXT ([INTERIOR]) Button to display the next faulted zone and press the [BYPASS] Button to bypass that zone.
5. Repeat Step 4 for each zone to be bypassed. To cancel any bypassed zone, at the zone display, merely press the [BYPASS] Button once again.

After all faulted zones are bypassed, press the [RESET] Button; "SYSTEM READY" will display, indicating that it is now safe to arm.

B. From the "DIRECTORY" Screen.

1. Enter code, then press the [FUNCTION] Button until "DIRECTORY" appears.
2. Press [ON/OFF] to display the directory. The number of zones will display.
3. Use the NEXT ([INTERIOR]) and PRIOR ([INSTANT]) Buttons to select the zone to be bypassed.
4. When the zone is displayed, press the [BYPASS] Button. Repeat for each zone to be bypassed. To cancel any bypassed zone, at the zone display, merely press the [BYPASS] Button once again.

Note: If Bypass is not enabled for the user code, the foregoing procedure will cause a 4-chirp rejection signal at the keypad, with the display "INVALID ENTRY / TRY AGAIN".

Easy Bypass (Do not enable in UL applications.)

Enable this feature by programming *Disable Code Entry for Easy Bypass*. Then, zones programmed for *Selective Bypass* may be bypassed quickly and easily as follows. (**Note:** This is *not* a high-security feature.)

1. At the "SYSTEM READY" or "ZONE FAULT" display, enter the zone number as a two-digit number (e.g., "01", "15", etc.). (Zones cannot be bypassed while the panel is armed.)
2. Press the [BYPASS] Button. To *unbypass* the zone, press the [BYPASS] Button again. (Steps 1 and 2 may be reversed and this feature will still function.)

Note: If *Bypass Faulted Zones* is programmed, pressing [*] and [BYPASS] Buttons simultaneously will bypass all zones in trouble (except Fire and PIR Zones) that are also

programmed for *Selective Bypass*.

Bypassing Interior Zones

Interior zones allow perimeter zones to be armed while part or all of the active interior remains disarmed. Two groups of Interior Zones may be programmed for each area. Pressing the [INTERIOR] Button will toggle between "I1", "I2", and "INTERIORS 1+2", which will be displayed along with the "BYPASS" indicator and respective zone descriptions. (**Note:** If only one group of Interior Zones is programmed, the "INTERIOR" messages will not display. When the [INTERIOR] Button is pressed, the "BYPASS" reminder will come on.) Pressing the [ON/OFF] Button within 10 seconds will bypass the selected interior group(s) without arming, otherwise *Interior Bypass* will time out and the system will revert to the regular disarmed state. All zones designated for the selected interior group(s) will be bypassed simultaneously when the system is armed.

ALARM INDICATION

Note: To silence an alarm, enter a valid User Code, then press the [ON/OFF] Button.

Should a burglary alarm occur, the red ARMED LED will flash, and the display will alternately read "ALARM", then the zones violated. Disarm the panel; the display will read "ALARM" and will continue to indicate the violated zones until the [RESET] Button is pressed or the panel is armed once again. The alarm conditions will then be stored in the Alarm History Log and the Total Event Log (see *HISTORY LOG*).

FUNCTION MODE

The keypad can provide a wide assortment of utility functions as summarized in the Functional Diagram (see *Appendix*). The functions are displayed in a prompting "yes/no" format. To skip a function, answer NO (press [INSTANT] Button); to select and execute a function, answer YES (press [INTERIOR] Button or [ON/OFF] Button). The complete function list is provided here in its normal displayed sequence. However, since not all functions are designed for all systems (or intended for all users), *only functions that are applicable and active are displayed*. (For example, if no zones are bypassed, "DISPLAY ZN BYPASSED" will not appear.) Furthermore, functions that are intended for use by the installer or servicer will not be displayed. (**Note:** Functions may be manually scrolled forward or backward using the [FUNCTION] and [BYPASS] Buttons, respectively.)

Displayed messages are two lines long; hold down the [*] Key to display the second line. To return to normal keypad operation, press the [RESET] Button. (The keypad will automatically return to its normal operating mode if no activity is detected for longer than one minute.)

Note: (1) In all UL-listed applications and in high-security installations, only those users having valid codes can access the Function Mode. (2) Due to space constraints, RP3003LCD message displays are abbreviated.

Remember: (1) Functions that are not active, not programmed and/or not applicable to the user's authority level will be suppressed and will not display. (2) Press NO to skip a function; press YES to execute it. (3) The RP3003LCD displays abbreviated messages that autoscroll.

- **DISPLAY ZN FAULTS.** Press YES to identify all unsecured zones (within the keypad's area) while disarmed. Press the [INTERIOR] Button to scroll through the zones. (Zones may be bypassed in this mode by press-

ing the [BYPASS] Button.) Manually bypassed zones will be indicated when displaying status.

- **DISPLAY ZN BYPASSED.** Press YES to display zones that have been deactivated. (Zones may be unbypassed in this mode by pressing the [BYPASS] Button.) Press the NEXT Button to scroll through the zones.
- **DISPLAY ZN DIRECTORY.** Press YES to display a list of all programmed zone descriptions in the keypad area. Press the NEXT Button to scroll through the zones. (Zones may be bypassed in this mode by pressing the [BYPASS] Button at the zone display.) To return to the system, press the [RESET] Button at any time.
- **ACTIVATE BELL TEST.** Press YES to activate the burg relay output (while disarmed) for about 2 seconds. If the device does not sound, it may be defective.
- **DISPLAY PHONE #'S.** The panel can function as an autodialer to any of four programmed telephone numbers. (Telephone numbers must be programmed through Napco PCD3000 Quickloader software.) Select Telephone #1-4 using NEXT and PRIOR Buttons, then press the [ON/OFF] Button. Pick up the phone to initiate dialing of the displayed number. (The phone will appear to be disconnected while dialing but will return to normal after a few seconds.)
- **DISPLAY SYS TRBL.** Press YES to check trouble (LOW BATTERY, AC POWER LOSS, etc.). Wait for the display to scroll through multiple system troubles, or use the NEXT and PRIOR Buttons to manually scroll.
- **DISPLAY FIRE ALARM.** To display Fire Zone(s) in alarm, access *DISPLAY FIRE ALARM* and scroll through the zones using the [INTERIOR] Button. Correct the problem, then press the [RESET] Button to restore the "SYSTEM READY" condition.
- **DISPLAY FIRE TRBL.** To display Fire Zone(s) in trouble, access *DISPLAY FIRE TRBL* and scroll through the zones using the [INTERIOR] Button. Correct the problem, then press the [RESET] Button to restore the "SYSTEM READY" condition.
- **DISPLAY OP/CL.** Napco's PCD3000 Quickloader software offers a comprehensive array of programmable opening and closing suppression windows, by area, for all days of the week, for both normal and holiday schedules. A two-line display of the programmed schedule may be read at the keypad. The first line indicates:
 - the day of the week
 - opening or closing suppression window
 - "AUTO", if autoarming
 - normal (or delayed) schedule (see below)

To scroll through the days of the week, use the NEXT and PRIOR Buttons. To display the second line, hold down the [*] Key. (Note: The second line will display briefly whenever a new schedule is selected.) The second line indicates the starting and ending times of the suppression window.

The closing of any suppression window may be delayed up to four hours at the keypad, or the window may be totally disabled, up to one week in advance. Select the *DAY/OP/CL* schedule using the NEXT and PRIOR Buttons. Select the delay (1-4 hours) or disable using the [ON/OFF] Button. Note: If the schedule includes autoarming, arming will be delayed accordingly. Also see *Autoarm Function*. (Autoarming can be disabled or delayed by

area using PCD3000 software.)

- **ACTIVATE OVERVIEW.** This mode provides a system status display of all partitioned areas at a glance. (Note: The keypad selected for the Overview Mode will remain in that mode. To convert the keypad back to its original use as an area keypad, enter the Function Mode and access *DEACTIVATE OVERVIEW*. The display will revert to "SYSTEM READY".) Also see *Overview Mode*.
- **ACTIVATE CHIME.** Press YES to sound a tone at the keypad when a *Chime Zone* is violated. The duration of the tone is programmable. A "C" will appear in the display (RP3005LCD only) as long as the Chime Mode is active. To turn off the Chime Mode, press YES at the *DEACTIVATE CHIME* function.
- **ACTIVATE WATCH.** This option, if programmed, permits all zones designated as *Day Zones* to be turned on. When selected, a "w" will appear in the display (RP3005LCD only) as long as the Watch Mode is active. To deactivate the Watch Mode, arm, then disarm.
- **GUARD TOUR (ON/OFF).** A Guard-Tour Schedule is programmable through Napco's PCD3000 Quickloader Software. *GUARD TOUR* is toggled on and off by pressing the YES Button. When *GUARD TOUR* is toggled on, the programmed starting time of the tour will be signalled by all guard-tour keypads pulsing and displaying "DO GUARD TOUR / ENTER CODE". The tour must be started within 10 minutes of the signal. Entering the Guard-Tour Code at each keypad will silence its sounder and restore its "SYSTEM READY" display. Silencing the last keypad ends the tour. If the tour is not completed within the programmed duration, the panel may be programmed to report to the central station, trip the burg relay (or one of the 96 external relays), or both (or neither).
- **RESET SYSTEM TRBL.** System troubles normally latch and display and sound at the keypad. Pressing the [RESET] Button will silence the sounder; "SYSTEM READY" will be displayed. Correcting the trouble will clear most system trouble indications, however the following system troubles require a Level-2 or -3 code for manual reset (enter code; access *RESET SYS TRBL* then press [ON/OFF].)
 - EZM Tamper
 - Keypad Tamper
 - Sensor Watch
 - Service Reminder

Note: (1) If a system trouble is not corrected, it will redisplay after 5 minutes. (2) If one or more of the foregoing system troubles appear during the first 5 minutes after power-up, they will be cleared automatically.

- **RESET SENSOR MSG.** Press YES to reset a PIR Supervision system trouble.
- **START EXIT TIME.** If the central station ringback signal has not been received within about 30 seconds, a communication problem may exist. Press YES to start exit delay manually.
- **FAULT FIND.** This troubleshooting aid will help the installer locate swingers. When accessed, two things occur: (a) the loop response of each zone is set for the fastest response time, and (b) causing or repairing a fault activates the sounder for about 3 seconds. Tapping and poking at suspect points, the installer can easily locate swingers by listening for the beep. This eliminates the need of returning to the keypad to visually check after

each attempt. Press the [RESET] Button to restore normal operation. (Arming the system automatically cancels the Fault-Find Mode.)

- **ACTIVATE LOCATE.** This feature will help the user find zone troubles and indicate when they are repaired. When accessed, the sounder will come on and the display will read "LOCATE", then scroll through the zones in trouble. As each zone is corrected, the sounder will stop momentarily, signalling its repair, and the display will indicate the remaining zones in trouble. The sounder and display will continue in this manner until all zones are repaired, or until the [RESET] Button is pressed.
- **EZM ZONE FIND.** To find the physical location of an EZM, enter the number of any zone on that EZM, then press the [ON/OFF] Button. This will cause the EZM sounder to pulse continuously until silenced. To silence the sounder, press the [RESET] Button on any keypad.
- **ACTIVATE DIALER TEST.** Press YES to send a digital dialer test code to the central station using the system account number. (Be sure to notify the central station of the impending test.) A successful test will clear a *Failure to Communicate* system trouble.

The History Log documents the 800 most recent events.

Note: Event-log displays comprise two lines.

- **DISPLAY ALARM LOG.** (*Not available with RP3003LCD Keypads.*) Displays most recent alarm events. Line 1 displays event and date. Line 2 displays time, area and zone. To check previous alarm events, scroll back using the PRIOR Button.
- **DISPLAY TOTAL LOG.** (*Not available with RP3003LCD Keypads.*) Displays most recent events of all types. Line 1 displays event and date. Line 2 displays time and, if applicable, area and zone or user. To check previous events, scroll back using the PRIOR Button.
- **DISPLAY FIRE LOG.** (*Not available with RP3003LCD Keypads.*) Displays most recent fire events. Line 1 displays event and date. Line 2 displays time, area and zone. To check previous fire events, scroll back using the PRIOR Button.
- **DISPLAY OP/CL LOG.** (*Not available with RP3003LCD Keypads.*) Displays most recent openings and closings. Line 1 displays event and date. Line 2 displays time, area and user. To check previous events, scroll back using the PRIOR Button.
- **DISPLAY SYSTEM LOG.** (*Not available with RP3003LCD Keypads.*) Displays most recent system events. Line 1 displays event and date. Line 2 displays time and other pertinent information, where necessary, depending upon event. To check previous system events, scroll back using the PRIOR Button.
- **TO ARM IN 1-4 HRS.** Use this function to (a) delay programmed autoarming up to 4 hours, 15 minutes or (b) initiate autoarming in 4 hours, 15 minutes as follows. **Note:** Autoarming may not be used in UL installations.

At the "AUTOARM IN 1-4HR" display:

- For 1hr, 15min delay: press [1], then [ON/OFF].
- For 2hr, 15min delay: press [2], then [ON/OFF].
- For 3hr, 15min delay: press [3], then [ON/OFF].
- For 4hr, 15min delay: press [4], then [ON/OFF].

Fifteen minutes prior to arming, the siren will sound a

2-second warning and the keypad will begin a 15-minute countdown with the sounder pulsing. (The sounder may be silenced by pressing the [RESET] Button, but it will come back on one minute before arming.) Within this countdown window, arming may be delayed an additional 1 to 4 hours, as above, or autoarming may be cancelled by arming and disarming the panel.

- **DISPLAY AUTO ARM SCHD.** Press YES to display the autoarm schedule programmed by the PCD3000 software. Use NEXT and PRIOR Buttons to scroll forward and back through the week. While the programmed schedule cannot be changed at the keypad, autoarming may be delayed up to four hours at the keypad, or it may be totally disabled, up to one week in advance. Select the day using the NEXT and PRIOR Buttons. Then select the delay (1-4 hours) or disable using the [ON/OFF] Button. Fifteen minutes prior to autoarming, the siren will sound a 2-second warning and the keypad will begin a 15-minute countdown with the sounder pulsing. Within this countdown window, arming may be delayed an additional 1 to 4 hours (using *TO ARM IN 1-4HRS* function), or autoarming may be cancelled by arming and disarming the panel.
- **ACTIVATE PROGRAM.** At Keypad No. 1, press YES to activate the User Program (Program-1) Mode or Dealer Program (Program-2) Mode, depending upon the code entered. Scroll through the programmable functions using NEXT and PRIOR Buttons. **Note:** Keypad No. 1 may be located in any area.
- **ACTIVATE DOWNLOAD.** Used on-site for remote downloading of a control-panel program from the PCD3000. Press YES to initiate the data transfer.
- **DISPLAY RF XMITTER STAT.** Press YES to check the status of up to 96 transmitters. The keypad will display:
 - ☒ transmitter number (XM01-XM96);
 - ☒ transmitter ID code (6 digits);
 - ☒ point number (PT1-PT4);
 - ☒ zone to which transmitter is mapped (Z01-Z96);
 - ☒ status of transmitter:
 - NoData: transmission not yet received;
 - Normal: transmitter's zone normal;
 - Open: transmitter's zone open;
 - LoBatt: transmitter battery low;
 - Tamper: transmitter case open;
 - S.Fail: supervisory failure (test transmission not received within prescribed time);
 - ☒ relative signal strength of the last transmission, on a scale of 1-15 (15 being the strongest). ("SS—" indicates transmission not yet received.) **Note:** Up to four receivers may be connected to the MA3900. Only the highest signal strength will be displayed.
- **RELAY CONTROL.** Press YES to check the status (all on or all off) of up to 8 groups programmed with any combination of up to 96 available relays. The group number will display with a related description (programmable only with Napco's PCD3000 software). Scroll through the groups using the NEXT and PRIOR Buttons; change the status of the displayed group by pressing the [ON/OFF] Button.

KEYPAD MESSAGES

The RP3005LCD Keypad can display the following messages. The RP3003LCD will display similar abbreviated messages that may scroll through two screens.

SYSTEM READY CW - All zones operating; system can be armed. *RP3005LCD only*: C = Chime Mode on; W = Watch Mode on; 1 through 8 = Area.

PLEASE WAIT - Panel reporting to central station on arming. Wait for ringback signal to exit.

EXIT TIME XXX SI - Exit delay in progress. XXX = exit time remaining in 10-second decrements; *RP3005LCD only*: S = Service Code active; I = arming with Instant protection.

ENTRY TIME XXX - Entry delay in progress. XXX = entry time remaining in 10-second decrements.

SYSTEM ARMED SI - Panel armed. *RP3005LCD only*: S and I indications as above.

CHECK STATUS CW - One or more zones not secured. Display status for zone description(s). C and W indications as above.

CAN'T ARM / ZONES NOT NORMAL - Arming attempted with system trouble or Priority Zone in trouble. Display Status. Correct trouble to arm.

DAY ZONE TRBL - Trouble condition on Day Zone, followed by one or more zone descriptions.

INVALID ENTRY/TRY AGAIN - Wrong code/time/area number entered.

CAN'T ARM SYSTEM - In *Overview* or *Manager's Mode*, one or more areas not secured.

ALARM - Alarm condition, followed by one or more zone descriptions.

*******FIRE******* - Fire alarm condition, followed by one or more zone descriptions.

FIRE TROUBLE - (With ****Fire Status****) Trouble condition on a Fire Zone. Press the [RESET] button to silence the sounder. Correct the trouble, then press the [RESET] button again.

FIRE ALARM - (With ****Fire Status****) Alarm condition on a Fire Zone. Press the [RESET] button to silence the sounder. Correct the cause of the alarm, then press [RESET] again.

ZONES BYPASSED - (When *Zones Bypassed* displayed) Indicates zones that have been deactivated.

OV(R-----) - Overview Mode (Status of up to 8 areas): R = Zone Ready; also, Z = Zone Fault; A = Armed; B = Burglary Output; F = Fire Output; T = Fire Trouble;

C = Check Trouble; D = Display Mode; N = Fire Area Normal.

SYSTEM TROUBLE - (When *System Troubles* displayed) Indicates system trouble(s) (below).

AC POWER LOSS - Power failure. Check power transformer. Check for blown fuse or circuit breaker; general power outage.

SENSOR FAILURE - No trip detected on PIR Supervision Zone within programmed Sensor-Watch time. To reset, press YES Button at "RESET SENSOR MSG" function display.

BUS FAIL - Failure of 4-Wire Bus. Check Terminals 11/12.

FAIL TO COMM - Unsuccessful communication to central station. Note: Will also display if panel improperly programmed to report; i.e., *Report Alarm, Report Codes, Subscriber ID Numbers*, etc. must be programmed.

TELCO FAIL - System trouble displays after a programmed delay.

EZM FAILURE XX - Failure of an expansion zone module. XX = module number.

LOW BATTERY - Battery below 11 volts. If not recharged within 24 hours, replace it.

TAMPER EZM XX - EZM module cover removed. XX = module number.

TAMPER KEYPAD XX - Keypad cover removed. XX = keypad number.

KEYPAD FAILURE X - Keypad defective. X = keypad number.

XX OUT OF SYSTEM - Keypad inoperative (XX = keypad number; call for service).

ERROR USER MEM - Internal memory error. Select **RESET SYSTEM TBL**. Press the [ON/OFF] button then the [RESET] button.

ERROR DLR MEM - Same as above.

ALARM - (After panel disarmed) displays zones violated.

FAULT FIND - Fault-Find Mode activated.

LOCATE - Locate Mode activated.

Service Message

A service message can be programmed through the PCD3000 Quickloader (event-schedule screen) to remind the user to arrange for scheduled maintenance. At the programmed date and time, the keypad sounder will start to pulse and the display will read "SERVICE REMINDER" (RP3005LCD) or "SERV" (RP3003LCD). This condition will behave as a system trouble and may be cleared as such, i.e., press [RESET] to silence sounder; access **RESET SYSTEM TRBL**, then press [ON/OFF].

5. GLOSSARY & PROGRAMMING INFORMATION

Note: Displayed messages shown are for the RP3005LCD keypad. RP3003LCD messages are similar but abbreviated. Refer to the MA3900 Programming Manual (WI777) for address numbers.

Abort Delay

A delay period that allows cancellation of the central-station report. This is done by disarming the control panel within the delay period. Program zones for *Abort Delay*; see *Time Selection* for delay time.

Note: If *Abort Delay* is selected for a 24-Hour Zone, the zone must be cleared before disarming the panel.

Ac Failure

Ac-Fail Report Delay

If ac power is removed from the control panel, "AC POWER LOSS" will display at the keypad with a flashing "SYS TBL" reminder and a pulsing sounder. Press the [RESET] Button to silence the sounder; the "SYS TBL" reminder will remain on and "SYSTEM READY" will appear in the display. If a User Code is entered within 5 minutes, the panel may be armed successfully. After 5 minutes, the system trouble will again display.

Ac Failure may be programmed to activate the burglary output or any external relay, and/or report to a central station (program *Panel AC-Fail Report Code*). An alarm and/or restore report to the central station will occur immediately unless an *Ac-Fail Report Delay* is programmed (see *Time Selection*). *Ac Failure* is logged immediately upon detection.

Access Control

Access Control (Panel Access) on Auxiliary Relay

Auxiliary Relay Access Control Time

Keypad Access

Access Only

Access Logging

Note: The MA3900 has not been evaluated by UL for compliance with UL294 (Access Control Systems).

If *Access Control on Auxiliary Relay* is selected, entering the Access Code while disarmed will trip the panel's Auxiliary relay. This is commonly used to activate a door strike for the purposes of remotely unlocking a door. Each keypad is individually selected for *Panel Access* (see *Keypad Features*). Also program *Auxiliary Relay Access Control* time (see *Time Selection*). **Note:** Do not program the Auxiliary Relay as an output on alarm. Also, do not program *Enable Brownout Limits on Ac Failure*.

Keypad Access is selectable for any keypad 1 through 8 by appropriate programming of the Access Byte of any User Code; program the Access Byte for those keypad numbers (1 through 8) that are to respond to the User Code (see *Access-Control Keypads* and page 4 of the Programming Workbook, WI777). Note, however, that if the Access Byte is programmed, the code will no longer function as an Arm/Disarm Code. Also, if *Access Only* is programmed for any keypad, that keypad will be dedicated for keypad access. It will then display "ENTER CODE" and will no longer be capable of arming or disarming.

Entering a valid code at the keypad will cause a 5-second output on the keypad's PGM line with a pulsing sounder and the display "**ENTER NOW**". If *Access Logging* is programmed, keypad access control will be added to the

event log, by keypad.

An RB1000 Relay may be used to activate a door strike. Power to the door strike should be supplied from an independent source.

Access Number for Outside Line

Some subscribers will have a telephone system that requires one digit to access an outside line before the telephone number can be dialed. Also, the first dial tone encountered (prior to the access number) may have a frequency that is different from that of the accessed dial tone (440Hz). One or more 4-second Pre-Dial Delay "D"s may be entered before the access number instead of a dial tone with frequency "E". See *Pre-Dial Delay; Telephone Numbers*. **Note:** The panel features automatic dial-tone detection and will normally not require any "E"s.

If the subscriber's system uses an access number, contact the telephone-equipment supplier to find out if a dial tone other than 440Hz is received prior to dialing the access number. If the communicator must delay before dialing the access number instead of attempting to recognize the dial tone, find out how many 4-second delays must be programmed.

Alarm on Day Zone See Day Zone

Alarm Outputs (See Wiring Diagram for UL requirements.)

The MA3900 has three Form-C relay outputs: *Burglary*, *Auxiliary* and *Reset*. Each has a related jumper (B, A, and C, respectively) that may be cut for dry contacts.

The following table summarizes wiring for signalling an alarm in typical installations. See *Time Selection* for timeout durations.

OUTPUT	WIRING	REMARKS
Burglary Pulsing Fire*	Bell on 5(+) & 14(-)	Single bell; program Burg Relay for Burg; Pulsed Burg for Fire
Aux. Relay	6(C); 7(NC); 8(NO)	
Fire Lug	E9	See Fire Lug
Reset Relay	E22(C); 28(NC); 15(NO)	
Reset Relay as Smoke Reset	28(+); 29(-)	To smoke power.
*For UL Residential Fire installations, cut Jumper PS and install Jumper JP6.		

Alarm Outputs

In UL installations, (1) see *Time Selection* for timeout requirements; (2) combination residential burglary/fire systems require distinctly different signals for burglary and fire.

Note: All relays are "wet" contacts. For dry contacts, cut respective jumper (see *Wiring Diagram*).

Alarm/Alarm Restore Telco 1/Telco 3 See Report Telco 1/Telco 3

Alarm/Alarm Restore Telco 2 See Backup Report on Telco 2

Alarm Verification

An alarm on any Fire Zone programmed for Alarm Verification will cause all zones to power down for 12 seconds. (All devices must be wired with + power on Terminal 13.)

After this time, power is restored and a 4-second power-up time is started. Thereafter, the zone will be active again. This represents a total processing delay of 16 seconds from the time the alarm is first detected. If an alarm condition still exists at this time or reoccurs within 2 minutes, an alarm will be initiated, otherwise the zone will return to its original state. **Note:** A zone programmed for *Alarm Verification* must be programmed as a *Fire Zone* as well.

Ambush

A two-digit code that is entered immediately prior to (and as part of) the regular Disarm Code. This will access the Ambush Zone, typically causing a silent report to be sent to a central station. Thus, should a user be forced to disarm by an assailant, he can silently signal an emergency while appearing to be merely disarming the system. The Ambush Zone will automatically report when programmed to report on alarm.

To program the ambush feature, (a) program Ambush to report on alarm; (b) enter 2 digits as the Ambush Code; and (c) enter an Ambush-Zone Alarm Report Code. Each keypad is enabled for Ambush individually (see *Keypad Features*).

Inform the user what the Ambush Code is, and that his Arm/Disarm Code must be entered less than 10 seconds after the Ambush Code for an ambush report to be sent.

Answering Machine Pickup Without Line Seizure See *Callback-Method Download*

Anti-Jam Time

If the communicator does not detect a dial tone within 12 seconds, the *Anti-Jam* feature will be activated. That is, the communicator will go off line for a 16-second anti-jam interval in order to free the telephone circuit from an incoming call, then make another 12-second attempt at dial-tone detection. If still unsuccessful, the communicator will again go off line for 16 seconds, then proceed to dial anyway.

Areas

Zone Area 1–Zone Area 8

Priority Area Arming

Although the default program will automatically set up Zones 1 through 8 for *Zone Area 1*, the panel may be partitioned into up to eight areas. Each zone must be assigned to at least one area. Gaps in areas are not permitted. If a zone is selected for more than one area, that common zone will not arm until all areas are armed. If any zone disarms, the common zone will disarm.

In a multiple-area system, be sure to also program

- *Enable User Code by Area* (see *User Codes/Authority Levels*);
- *Keypad Area Assignments*
- *Bell Control* (determines which bells an area may silence);
- *Subscriber Opening/Closing ID Numbers* and *Event ID Numbers* (if reporting);
- *System Trouble Subscriber ID Number*

If *Priority Area Arming* is selected, all *Priority Areas* must be armed before any *Arming Areas* can be armed.

Arm Lug (Lug E4)

Lug E4 (ARM) will go to approximately 1Vdc when all areas in the system are armed. This lug may be used for auxiliary equipment. (For use, refer to the instructions furnished with

the device.)

Auto Bell Test on Arming (Required for UL Mercantile installations.)

This will activate the bell output briefly 10 seconds after the area is armed. If the alarm does not sound, the device may be defective.

Auto-Bypass (Do not program for UL installations.)

Auto-Bypass Re-entry

Zones programmed for *Auto-Bypass* will be bypassed (automatically removed) if in trouble when arming. A momentary beep will sound at the keypad to warn that the system has been armed without the protection of the auto-bypassed zone. (Note that the exit/entry door must be closed before arming, otherwise the Exit/Entry Zone will be auto-bypassed.) **Note:** A zone in trouble that is not programmed for *Auto-Bypass* will cause an alarm on arming after a 10-second arming delay.

If *Auto-Bypass Re-entry* is selected, securing a zone that is programmed for *Auto-Bypass*, while armed, will cause that zone to re-enter the system in an armed state.

Auto Disarm Rearm Delay

If the panel was auto-disarmed on schedule and a rearm delay is programmed (see *Time Selection*), the panel will automatically rearm after the delay if no activity has been detected.

Auto-Reset

Auto-Reset After Burglary Output Timeout

If a zone signals an alarm and is selected for *Auto-Reset*, it will automatically rearm itself as soon as the alarm condition is cleared. *Auto-Reset* may be delayed to occur after the Burglary Output timeout period by selecting *Auto-Reset After Burglary Output Timeout* and *Auto-Reset*. Zones 1 through 96 that are not programmed for *Auto-Reset* will not be capable of signalling another alarm until (a) the cause of the alarm has been corrected and (b) the control panel is disarmed. Also see *Swinger Shutdown*.

Auxiliary Relay See *Alarm Outputs*

Backup Report on Telco 2

If *Backup Reporting* is selected and the communicator does not reach the first telephone number after two attempts, seven attempts will be made to reach the second telephone number. Enter *Subscriber Identification Numbers* for Telephone 2 and other information required for Telephone 2. Also program *Backup Report on Telco 2*. Any zone programmed to report to Telco 1 will backup report to Telco 2. **Note:** Subscriber Identification Numbers for both Telephones 1 and 2 must be entered, even if they are the same.

Battery

12Vdc standby power source in the control panel to provide backup protection in the event of a power loss. Napco's RBAT4 (optional) is rated at 4 ampere-hours, the RBAT6 (optional) at 6 ampere-hours. The battery is an integral part of the system and must be installed, even if ac power is present. Change the battery every 5 years or as required.

Bell Control

In any system, the ability to silence any combination of alarm devices (relay outputs) initiated from any area. *Bell*

Control must be programmed for all systems to be able to silence an alarm. For example, in a two-area system, each area could be programmed to silence only those alarms initiated within its own area; or both areas could be programmed to silence an alarm initiated from either area.

Burglary Lug (Lug E10)

Lug E10 (BURG.) will go to about 1Vdc when the Burglary Relay is tripped. This lug is intended for connection to UL-listed devices rated 5mA maximum and capable of operating over the voltage range of 8 to 13.0Vdc (12V, special application). Use Napco Harness Part No. WL1 for connection.

Burglary Relay See *Alarm Outputs*

Bus Failure

Communication failure on the 4-wire burglary bus will cause a system trouble condition and a report to the central station. Program System Trouble Reports and Report Codes for the 4-Wire Bus.

Bypass Faulted Zones

If programmed, pressing the [*] and [BYPASS] Keys simultaneously will bypass all zones in trouble (except Fire Zones and PIR Zones) that are also programmed for *Selective Bypass*. The message, "BYPASSED ALL ZONE FAULTS" will display.

Call Waiting See *Disable Call Waiting*

Callback-Method Download

Answering Machine Pickup Without Line Seizure

Disable Callback Download (Required for UL installations)

Disable Answering Machine Download (Required for UL installations)

Disable Function-Mode Download

Number of Rings Before Pickup

Data may be downloaded remotely to the panel after a programmed number of rings (3 to 15) and a control-panel confirmation callback. Program the number of rings in Location 4089 (if not programmed, the panel will pick up after 15 rings.)

This method will accommodate an answering machine at the site. (Be sure that *Disable Answering Machine Download* is *not* programmed.) The answering machine will pick up on its programmed number of rings, as usual. The control panel will then listen for the signal from the PCD3000 software and seize the line from the house phones as well as the answering machine and the connection will subsequently be established. **Note:** The number of rings programmed into the panel must exceed that of the answering machine.

Program *Disable Callback Download* to prevent unauthorized downloading to an unattended panel. Program *Disable Answering Machine Download* to inhibit downloading to a telephone connected to an answering machine. Program *Disable Function-Mode Download* to prevent downloading at the keypad.

Cancel Next Test Timer Report on Any Report See *Test Timer*

Chime

This annunciator feature may be used on any zone to sound a tone at the keypad while disarmed when the zone goes into trouble. Access the *ACTIVATE CHIME* function to

enable or disable the Chime Mode. This feature is programmable by zone and for duration of tone (see *Time Selection*). A time must be programmed for the chime to function.

Clear Program

Erases the dealer program. To clear, access Location 4091 and press the [ON/OFF] Button. (Use this feature to start a new customized default program.)

Closing Report

Closing Report Only on Force Arm

Force Arm

Include Selective/Group Bypass In Force Arm/Status

Status Report

On arming, the communicator can transmit a unique Closing Code for each user and a status report that identifies the problem zone to the central station. Note that *Subscriber Identification Numbers* and a Closing Code must be entered for any closing report.

Select which users will report closings for each telephone number, even if *Closing Only on Force Arm* is selected. Normally, a closing report will consist of the Closing Code and the number of the user that armed. If the user armed with an auto-bypassed zone (or selective/group bypassed zone if *Include Selective/Group Bypass In Force Arm/Status* was programmed), the *Force Arm Code* will also be sent.

Select *Closing Report Only on Force Arm* to report only when arming with an auto-bypassed zone (and selective-/group-bypassed zone if *Include Selective/Group Bypass In Force Arm/Status* is programmed).

Select *Status Report* to send a closing followed by a status report that identifies the problem zone(s). A typical Status Report is represented by the following example.

Example (4/2 Format). A burglar breaks into a commercial establishment during the night, breaking the window foil on Zone 5. The Open/Close Subscriber Identification Number is "1234"; the Alarm Code for Zone 5 is "3,5" (Burglary Zone 5); the Subscriber Identification Number is "6789"; the Closing Code is "C". The communicator will send the following report to the central station.

When alarm occurs:

"6789 35" – Alarm, Zone 5

Closing Report:

"1234 C1" – Closing, User 1 (User 1 returned, inspected damage & rearmed; the same transmission would occur for User 11, 21, 31, etc.)

"1234 F5" – Trouble, Zone 5 (zone status at time of closing: Window foil still broken; Zone 5 auto-bypasses, repair required; the same transmission would occur for Zone 15, 25, 35, etc.)

Data Format

Consult the central station to find out which of the following formats to use.

Two-Digit or 4/2 Format. Some central-station receivers require that a four-digit Account Code followed by a two-digit Alarm Code be sent in each report. *Example.* In a certain installation, the Alarm Subscriber Number is "1234"; a burglary alarm occurs on Zone 1. The Alarm Code for Zone 1 is "3,1". The communicator will send "1234 31" (Account No. 1234; Alarm, Zone 1).

1400Hz Handshake/Kissoff. 1400Hz Handshake overrides 2300Hz Handshake if both are selected.

2300Hz Handshake/Kissoff. Used with the following receiver formats: Radionics, DCI & Franklin Slow; Radionics Fast; Sescoa, Vertex, DCI & Franklin Fast; Radionics BFSK. 1400Hz Handshake overrides 2300Hz Handshake if both are selected.

Zone Number on Pulse Alarm. If selected, an Alarm Code need not be programmed (the zone number will replace the Alarm Code), however codes for restore, trouble, etc. are still required. Thus, in the foregoing example, if "E" is the designated Restore Code, and Zone 96 trips and is restored, the communicator will send "1234 96" (Account No. 1234; Alarm, Zone 96) followed by "1234 E6" (Account No. 1234; Zone 96 Restored).

Single-Digit Event Code Format. The single digit sent for a particular event can be either the Event Code or one digit in the Alarm Code.

Sum-Check Format. Sum Check is a sophisticated data format used to enhance the speed and check the accuracy of the received transmission. This format should be preferred whenever the central station is capable of receiving it. After transmitting the Subscriber Identification Number and the Alarm Code, the communicator sends a verifying digit that is the sum of both. The receiver compares the verifying digit with the sum of the other numbers to check transmission accuracy.

3/1 with Extended Restores. Some receivers require a three-digit Account Code followed by a single-digit Alarm Code. *Example.* In another installation, the Alarm Subscriber Number is "123"; an alarm on Zone 1 is restored. The Restore Code for Zone 1 is "E, 1". The communicator will send "123 E" (Account No. 123 Restored); followed by "EEE 1" (Restored, Zone 1).

Modem Formats. Modem formats (SIA, Point ID, Express, 4/3/1, Modem 2) are preset and automatic but require a type number for each zone. Program *Zone Type* as follows:

- Fire - "1" (Note: Not for Modem 2 Receivers)
- Panic - "2"
- Burglary - "3"
- Holdup - "4"
- Fire Supervision - "5"
- Fire Waterflow - "6"
- Gas Alarm - "7"
- Heat Alarm - "8"
- Sprinkler Alarm - "9"
- Auxiliary Alarm - "A"
- 24-Hour Aux. Alarm - "B"

Pager Formats. The control panel has provisions for dialing a pager phone number. The panel will wait for ringing, wait for silence, then send its data. *Caution:* Because there is no handshake/kissoff, *this feature should only be used for Double Reporting; it may not be used for Backup Reporting.* Only one report is sent for any call. Pager digits are limited to "0" through "9". Digits represented by "A" through "F" will be converted to "0"s for transmission purposes. Pager formats are 9 digits, arranged as illustrated by the following examples:

Example 1. 000 301 1234

Alarms, restores, etc. are transmitted in a 3-3-4 arrangement, where

000 = Pager ID (always three zeros);

301 = Report Code (1 digit, programmable 0-9) and number of zone tripped (2 digits, 01-96);

1234 = Account Number (programmable).

Openings, closings, etc. are transmitted in a similar arrangement, where

000 = Pager ID (always three zeros);

301 = Report Code (1 digit, programmable 0-9) and user number (2 digits, 01-99);

1234 = Account Number (programmable).

Example 2. 000 012 1234

Keypad Report Codes and System Report Codes are transmitted in a similar 3-3-4 arrangement, where

000 = Pager ID (always 3 zeros);

012 = Report Code (programmable 000-099);

1234 = Account Number (programmable).

Compatible Receivers. The following receivers are compatible with the MA3900.

- **FBI CP220.** *Formats:* Ademco Slow; Silent Knight Slow; Silent Knight Fast; Sescoa; Vertex; DCI; Franklin Slow; Franklin Fast; SIA; Radionics Slow; Radionics Fast; Radionics BFSK; FBI 4/3/1; Universal High Speed.
- **Ademco 685.** *Formats:* Ademco Slow; Silent Knight Slow; Silent Knight Fast; Sescoa; Vertex; DCI; Franklin Slow; Franklin Fast; Radionics Slow; Radionics Fast; Radionics BFSK; Universal High Speed; Ademco Point ID; Ademco Express.
- **Radionics 6500.** *Formats:* Ademco Slow; Silent Knight Slow; Silent Knight Fast; Sescoa; Vertex; DCI; Franklin Slow; Franklin Fast; Radionics Slow; Radionics Fast; Radionics BFSK; Universal High Speed; Radionics Modem 2.
- **Osborne-Hoffman Quickalert.** *Formats:* Ademco Slow; Silent Knight Slow; Silent Knight Fast; Sescoa; Vertex; DCI; Franklin Slow; Franklin Fast; SIA; Radionics Slow; Radionics BFSK; Universal High Speed; Ademco Point ID; Ademco Express.
- **Silent Knight 9000.** *Formats:* Ademco Slow; Silent Knight Slow; Silent Knight Fast; Sescoa; Vertex; DCI; Franklin Slow; Franklin Fast; Radionics Slow; Radionics Fast; Radionics BFSK; Universal High Speed; SIA.

Day Zone(Open; Short)

Alarm on Day Zone

Disable Auto-Reset on Day Zone

Reset Day Zone with Arm/Disarm Only

Enable Watch, Area 1-8 (By Area)

A *Day Zone* will give an audible and visual indication at the keypad if there is a problem on the loop while disarmed. Open- and short-circuit conditions are programmed separately, by zone. This feature may be used to warn of a problem (a break in a window foil, for example) during the day, when the panel is not normally armed. When the Day Zone is tripped, "DAY ZONE TRBL" and the zone number(s) will alternately display at the keypad and the sounder will pulse. Press the [RESET] Button to silence the sounder and reset the keypad. "ZONE FAULT" will be displayed until the condition is corrected. If *Reset Day Zone With Arm/Disarm Only* is programmed, arm and disarm the panel to reset the Day-Zone indication at the keypad.

If *Alarm on Day Zone* is programmed for a zone, a Day Zone condition will cause the alarm outputs programmed for that zone (sirens, relays) to activate.

Note: (1) If a zone is programmed for both *Day Zone Open* and *Day Zone Short*, either condition must be reset before the other can activate. (2) *Day Zone Short* will not function if *No EOL Resistor* is also programmed.

Report Trouble or *Trouble Restore* is programmed in conjunction with *Day Zone Open/Day Zone Short* and *Trouble on Open/Trouble on Short* (the trouble reported will be that programmed under *Day Zone Open* and/or *Day Zone Short*).

Note: Do not program a Day Zone for 24-hour protection. The keypad will annunciate as a Day Zone but the panel will transmit an Alarm Code and a Trouble Code when tripped.

Program *Disable Auto-Reset on Day Zone* to prevent repeated Day-Zone trips. This will cause the keypad display and sounder to activate only once during any arm/disarm period.

If *Enable Watch* is selected (by area), zones programmed for Day Zone can only be activated when *ACTIVATE WATCH* is accessed. (See Section 3.) Arming and disarming will turn off the Watch Mode. If *Report Trouble* is selected, a trouble on a Day Zone will be reported only when the Watch Mode is on.

Dealer Security Code See *Master Security Code*

Dial-Tone Detection

The panel features automatic dial-tone detection to ensure that a dial tone is present before the communicator dials.

When an "E" is programmed before the first digit of an outside telephone number, the communicator dial-tone detection circuit is set to detect the standard 440Hz dial tone. The "E" is generally entered in the location immediately preceding the telephone number.

It may be necessary to program at least one 4-second pre-dial delay before a dial-tone detection "E". With certain nonstandard exchanges, pre-dial delay "D"s may be used without a dial-tone detection "E". (See *Access Number for Outside Line; Pre-Dial Delay; Telephone Numbers.*)

Digital Dialer Test

Activating the digital dialer test from the Function Menu (*ACTIVATE DIALER TEST*) will send the programmed report code to the central station. Program *DD TEST* for *SYSTEM-TROUBLE REPORTS* and enter a *DD TEST* Report Code. Note that in this case the report code received is not indicative of a system trouble, but is an indication of a successful transmission. Should the transmission fail, the keypad will display "FAIL TO COMM". This system trouble may be reset by pressing the [RESET] Button. Any successful subsequent transmission will also clear the system trouble.

Disable Answering Machine Download See *Callback-Method Download*

Disable Auto-Reset on Day Zone See *Day Zone*

Disable Auto Status

Non 24-Hour Zones that are open (or shorted) normally display "ZONE FAULTS" (while disarmed) followed by the zone number(s) and description(s). In high-security applications, program *Disable Auto Status*. Unsecured zones will then be indicated by a "CHECK STATUS" display. Status may be displayed manually using the *DISPLAY STATUS* function, however a valid user code will be required.

Disable Auto-Unbypass on Disarming

Normally, manually bypassed zones revert to active (disarmed) zones on disarming. Select this feature to maintain bypassed zones on disarming until manually unbypassed.

Disable Call Waiting (TouchTone® Dialing Only)

A digital communicator connected to a telephone line with *Call Waiting* may be disrupted by this feature. However, most lines with *Call Waiting* also have *Selective Call Waiting*, which permits the feature to be turned off by dialing a "*70" just before the telephone number. A "*" will be dialed by programming a "B".

If the installation has the *Call Waiting* feature, be sure that it also has *Selective Call Waiting*, and confirm the disable code with the telephone company. Then program this code ("B70") directly before the phone numbers (after dial-tone detection or pre-dial delay) in the telephone-number locations. See *Telephone Numbers*.

Caution: Should the user cancel his *Call Waiting* service, the communicator will dial a wrong number unless the phone number is corrected.

Disable Callback Download See *Callback-Method Download*

Disable Code Entry for Easy Bypass See *Selective Bypass* (Do not program in UL Installations)

Disable Code Entry for Function Mode Level 1

Intended primarily for residential applications, this feature eliminates the user code requirement to access the Function Mode (for Level-1 Users only), rendering the system more user friendly.

Disable Code Entry for Info Mode (Do not program in UL installations)

Program this feature to eliminate the user code requirement to access the Info Mode (Fire Keypads only). (This is intended for keypads mounted inside a locked housing.)

Disable Fire Reset (by Area)

Normally, pressing the [RESET] Button will momentarily remove power to the smoke detectors. If *Disable Fire Reset* is selected for any area, the [RESET] Button will no longer activate the Reset Relay so that the integrity of the smoke detector's Alarm Memory feature (LED indication) will be maintained. Also see *Alarm Outputs; Smoke Detectors*.

Disable Function-Mode Download See *Callback-Method Download*

Disable Openings/Closings

Provides the flexibility of disabling openings and/or closings from any area(s).

Disable Wait-for-Handshake/Kissoff

Causes data transmission to start immediately after the telephone number.

Disable Wait-for-Silence (Pager Format)

Causes data transmission to start immediately after the pager telephone number.

Double Reporting See *Report Telco 3*

"E" Lugs (E3, E5, E7, E9, E10, E11, E14, E18, E22)

E9 - See *Fire Lug*

E10 - See *Burglary Lug*

E22 - Common terminal for Reset Relay.

Use Napco Harness Part No. WL1 for field wiring. (All other lugs are reserved for future applications.)

Download Security Code See *Master Security Code*

Easy Arming

Permits quick arming by simply pressing the [ON/OFF] Button. Each keypad may be individually programmed for *Easy Arming* (see *Keypad Features*). Disarming still requires entry of a valid user code. Do not program *Easy Arming* in UL installations. If closings are reported, *Easy Arming* will report as User 99.

Enable Entry Warning Bell Chirp

Causes the burglary bell to "chirp" if the entry door is opened within 60 seconds after exit time has elapsed. This feature may be useful in cases where a keypad is not within audible range to remind a user to disarm if inadvertently exiting after exit delay has expired.

Enable Exit Delay Restart See *Entry/Exit Delay*

Enable Line Fault Test

Telco Line Test Delay

Enable Line Fault Test will cause the panel to monitor Telco 1. A failure will display as "TELCO-1 FAIL". Program this system trouble to activate the Burglary Output.

If a time is entered in *Telco Line Test Delay*, the line will be tested for the programmed duration before a system trouble is activated. A minimum of 30 seconds is recommended.

Enable Local Alarm on First Zone "AND" Trip See *Zone ANDing* (Do not program in UL installations.)

Enable Reporting to PCD3000

This feature allows a PC computer with Quickloader Software to function as a receiver. If programmed, all alarms sent to Telephone No. 1 will be sent to *PC PRESET* as well (regardless of whether or not transmissions to Telephone No. 1 were successful). *PC PRESET* must be in its standby mode for this feature to operate.

Enable User Code by Area See *User Codes/Authority Levels/Access Bytes*

Entry/Exit Delay

Entry/Exit 1; Entry/Exit 2

Entry Relay

Enable Exit-Delay Restart

Delays permit exit and entry through the Entry/Exit Zone(s) after the system is armed without setting off an immediate alarm. Entry delay allows the user time to enter and disarm the panel. Exit delay allows the user to leave the premises after the panel has been armed. Unless the keypad has been configured otherwise, the sounder will come on and will pulse during the last 10 seconds of entry delay to remind the user to disarm.

Two individually-programmable entry-delay times are provided to accommodate different entry zones. If two or more Exit/Entry Zones are entered in succession, the delay programmed for the last Exit/Entry Zone entered will take precedence over all others. Exit-Delay time and Entry-Delay time may each be programmed for up to 255 seconds (4¼ minutes). See *Time Selection*.

A remote relay may be programmed to trip upon entry (see *Programming Manual: Relay Event ID Codes, Area Entry Relays*), and remain on for a programmed duration.

If the system has been armed with *Exit-Delay Restart* enabled, when the exit door is opened and then closed, the programmed exit delay will restart at 60 seconds. Thus, if a long exit delay is programmed, it will be reduced to 60 seconds after exiting, yet still allow reentry before entry time starts. If re-entry occurs within that 60 seconds, exit delay will restart once again (and *only* once again) at 60 seconds.

If re-entry occurs within 60 seconds after exit delay has expired, the alarm will sound a 2-second warning (with the entry sounder) to remind the user to disarm. (*Exit-Delay Restart* may be useful in reducing false alarms caused by a user who re-enters the premises shortly after exiting.)

Note: In UL installations, maximum exit delay is 60 seconds; maximum entry delay is 45 seconds. In UL Mercantile installations, maximum entry delay is 60 seconds.

Entry delay may be cancelled by pressing the [INSTANT] Button prior to arming, however it will be restored automatically upon disarming. (When armed with Instant protection, an "I" will appear at the right side of the display.)

Exit/Entry Follower

A zone programmed as an *Exit/Entry Follower* will ignore detection during the exit delay, and only during entry delay if the Exit/Entry Zone is entered first. Thus, detection devices (passive infrared detectors, for example) along the path between the keypad and the exit/entry door will not signal an alarm during exit/entry delay under normal conditions. However, if a device in the Exit/Entry Follower Zone detects a violation when the exit/entry door has *not* first been entered, there will be no entry delay and the Exit/Entry Follower Zone will go into an instant alarm.

If the panel is armed with the entry delays cancelled (Instant protection), any violation on the Exit/Entry Zone or the Exit/Entry Follower Zone will cause an immediate alarm.

Expansion Zones

EZM Type

EZM PGM Armed Terminal Control

EZM Tamper See *Tamper*

Zones 9–96 are *expansion zones*, zones added to the basic system using expansion zone modules (EZMs). Any combination of EZM3004 (4 zones), EZM3008 (8 zones) and/or the 4-zone modules integral to each RP3005LCD keypad may be used. Refer to Section 2: *ADDING EXPANSION ZONES* and the *Wiring Diagram*. Also see the instructions accompanying each module for wiring information.

Regardless of how the modules are arranged, the expansion zones are divided into consecutively-numbered groups of four. Each 4-zone module comprises one group of zones; each 8-zone module comprises two groups. Each group is assigned a number.

For each EZM group, program *EZM Type* (two nibbles, left and right), as follows: *EZM Not Used*: leave both nibbles blank (••); *Burglary EZM*: enter "1" in the right nibble (•1).

If *EZM PGM Armed Terminal Control* is programmed for the EZM module, Terminal 6 on the module will go low when the areas programmed for that module are armed. This may be used to display *area-armed* status (for example) on an external LED. **Note:** (1) This terminal is intended for connection to UL-listed devices rated 5mA maximum and capable of operating from 8.0–13.0Vdc (12V, special application). (2) In two-group modules (EZM3008), only the lower of the two groups may be programmed.

Extended Format See *Data Format*

Fire

Keypad Fire

Any zone may be programmed for *Fire*. Connect normally-open devices across a Fire Zone. (The EOL2.2K end-of-line resistor must be installed.) A short across the zone will cause a fire alarm, which will be indicated at the keypad by a "FIRE" LCD display and pulsing sounder. An open circuit on the Fire Zone will identify a trouble and cause flashing "FIRE" LCD display and pulsing sounder after a 10-second delay. The sounder may be silenced using the [RESET] Button. The LED will go off within 30 seconds after reset if the alarm or trouble is cleared. For Smoke-Detector Reset, see *Alarm Outputs*.

Any fire condition that has not been restored will cause the zone number and description to scroll. To reset (acknowledge) the condition, enter a valid code, then press [RESET].

If *Keypad Fire* is programmed, pressing both [F] and [*] keypad buttons at the same time will sound a fire panic alarm and display "*****FIRE*****" at the keypad. The Keypad Fire function is supplementary to the hardwired zones. **Note:** This feature shall not be considered a substitute for listed manual initiating devices.

Fire Output (Lug E9)

Lug E9 (FIRE) will go to about 1Vdc when a Fire Zone programmed for *Fire Output* is tripped. This lug may be used for auxiliary equipment. (For use, refer to the instructions furnished with the device.) Use Napco Harness Part No. WL1 for connection.

Force Arm See *Closing Report*

Interior Zones by Area (Interior 1/Interior 2)

Interior 1 Normally Bypassed

Removal of a programmed group of interior zones from the system will permit freedom of movement throughout the premises but still afford protection from intrusion through armed perimeter zones. Two groups of zones may be programmed for any area; either or both may be selected.

Pressing the [INTERIOR] Button prior to arming will select between Interior 1 (i1), Interior 2 (i2) or both (INTERIORS i1 + i2). Select, then arm to bypass. The next time the control panel is disarmed, all bypassed zones will automatically revert to non-bypassed (disarmed) zones. **Note:** If only one group of Interior Zones is programmed, the "INTERIOR" messages will not display. When the [INTERIOR] Button is pressed, the "BYPASS" reminder will come on.

The bypassed zones may be displayed on the keypad (see *RP3005LCD FUNCTION MODE*).

If *Interior 1 Normally Bypassed* is selected, all Interior-1 Zones will always be inactive. The "BYPASS" reminder will always display, indicating that only partial protection will be provided upon arming. To temporarily restore interior protection, press the [INTERIOR] Button; the "BYPASS" reminder will go out upon arming, denoting full protection, however Interior 1 Zones will once again be bypassed the next time the panel is disarmed.

Include Selective/Group Bypass In Force Arm/Status
See *Closing Report*

Interior 1 Normally Bypassed See *Interior Zones by Area*

Jumpers (Refer to *Wiring Diagram* for UL configuration.)

A: Cut for dry contacts on the Auxiliary Relay.

B: Cut for dry contacts on the Burglary Relay.

C: Cut for dry contacts on the Reset Relay.

J5: Keypad Configuration jumper. Jumper is installed across top and center pins for normal operation. When configuring RP3005LCD keypads, move jumper across center and lower pins.

JP6 & PS: For Residential Fire. See *Alarm Outputs*.

JP7: 2-Wire Fire jumpers* Select Zones 7 and/or 8 for use as either 2-Wire Fire Zones or Burglary Zones. **Note:** If customizing a single-area default program, Zone 8 is configured as a 2-Wire Fire Zone. In a two-area default program, Zones 7 and 8 are configured as 2-Wire Fire Zones common to both areas; be sure to move JP7 Zone-7 jumper to the 2-WF position (see *Wiring Diagram*).

RP3005LCD Keypad Jumpers. Refer to the label on the circuit board fishpaper (LA1374) for jumper locations and a summary of settings.

JP1: Cut to enable Keypad Tamper.

W1 & W3: Cut both to disable touchpad backlighting.

W2: Cut to disable LCD backlighting.

RP3003LCD Keypad Jumpers. Refer to the label on the circuit board fishpaper (LA1390) for jumper locations and a summary of settings. See *Section 3: Configuring the RP3003LCD Keypad* for jumper selection.

Keypad Access see *Access Control*

Keypad Area Assignments

In multiple-area systems, assign an Area Number ("1" through "8") to each keypad. Note that each address comprises 2 nibbles; enter the *Area Number* in the right nibble.

Keypad Features

The following programmed system features will activate only if they have also been enabled at the keypad.

- Ambush
- Easy Arming
- Access Control
- Tour Station
- Keypad (Police) Panic
- Keypad Auxiliary Panic
- Keypad Fire Panic

Keypad Panic See *Panic Zone*

Keypad Sounder on Alarm

If a programmed zone goes into alarm, the keypad sounder will activate and will remain activated until the [RESET] Button is pressed or the system is disarmed.

Keypad Tamper See *Tamper*

Keyswitch Arming

The area will arm/disarm when the programmed zone is momentarily shorted (by means of a momentary key-switch). To supervise the keyswitch, program the zone for *Day Zone on Open*.

Line-Reversal Module, M278

The Line-Reversal Module allows the control panel to be monitored by a central station through leased lines. On alarm, the module reverses normal line-voltage polarity. For details, refer to the instructions furnished with the

module.

Loop Response (750mS required for UL installations)

Loop response is the amount of time in milliseconds (mS) that a normally-closed circuit must remain open, or a normally-open circuit must remain closed, to trigger an alarm. The slower the loop response, the more immune the system will be to intermittents ("swingers"). Loop response times for Zones 1 through 8 are programmed into the control panel; those for Zones 9 through 96 are selected at the respective keypad or expansion module. (Refer to keypad instructions and EZM Installation Instructions.)

Selectable loop-response times for Zones 1–8 are:

750mS (.75 sec.): The slowest loop-response time, recommended for use with magnetic contacts, window foil, etc. Unless programmed otherwise, loop-response time will be 750mS for all zones.

50mS (.05 sec.): Used for momentary Panic Buttons and area-protection devices, such as photoelectric eyes, passive infrared sensors, floor mats, etc.

10mS (.01 sec.): An extremely fast loop response used primarily for window bugs.

Low Battery (Required for UL Mercantile installations)

A low-battery system trouble will annunciate at the keypad when the battery terminal voltage drops below normal. This condition may signal a local sounding device, report to a central station (program *Panel Low Bat* Report Code), or both. If a battery is installed and low terminal voltage is detected, a restore will not occur until the battery is recharged to its specified level and passes a dynamic test. The dynamic test may be initiated manually by pressing the [RESET] Button, or it will be initiated automatically, every four hours, by the panel.

In wireless installations, when displaying rf transmitter status, a "LoBat" indication denotes a low-battery condition at the transmitter.

Master Security Code

Dealer Security Code

Download Security Code

The factory-programmed *Master Security Code* (printed on the label affixed to the micro can) is unique and cannot be changed. Use this code to enter the Program-2 Mode (Dealer Program Mode) to program (or change) the *Dealer Security Code*. If a Dealer Security Code is programmed, both the Dealer Security Code and the Master Security Code will work. However, should system RAM fail, only the Master Security Code will work.

The Dealer Security Code is required to enter the Program 2 Mode, thus allowing the dealer to program codes, zone features, reporting features and zone descriptions (see Programming Manual W1777). This code may be changed as required.

Important! The label containing the Master Security Code should be removed. Record the code in a secure place for reference as programming changes cannot be made without it (or the Dealer Security Code).

To change the Dealer Security Code, access the *PROGRAM 2* Mode. Advance to the "PROG" screen, then change the 6-digit code as required.

The *Download Security Code* is the six-digit code required to establish connection to the PCD3000 Quickloader Software.

Memory Failure

A User or Dealer Memory error will cause the sounder to pulse, the "SYS TBL" reminder to flash, and the display to read "ERROR USER MEM" or "ERROR DEALER MEM". Press the [RESET] Button to silence the sounder ("SYSTEM READY" will display, along with the "SYS TBL" reminder). Activate *RESET SYSTEM TROUBLE* to manually reset the system trouble. A Memory Failure can be programmed to activate an alarm output and/or report using its associated system Report Code.

Never Arm (May not be used for primary Burglary protection)

A zone programmed as *Never Arm* cannot go into alarm. If tripped, it will display at the keypad when the *DISPLAY STATUS* function is selected. A chime will sound at the keypad while armed or disarmed if *Chime* is also programmed for that zone, and enabled. This feature is suggested for use as a garage-door or driveway monitor, or similar application.

No EOL Resistor

Program for any zone not wired with a 2200Ω end-of-line resistor (Napco Part No. EOL2.2K). This will disable any short-circuit indication (if programmed, *Day Zone Short* is disabled). If not programmed, an end-of-line resistor must be installed. **Note:** This selection is automatically disabled for zones selected as *Fire*.

Number of Rings Before Pickup See *Callback-Method Download*

One-Button Arming See *Easy Arming*

Opening Report

Opening Report Only After Alarm Report (Do not program for UL installations)

Opening and closing reports are generally used in commercial installations. On disarming, the communicator can send an Opening Code for Users 1–96 (*Opening Report*), or it may transmit only when the control panel is disarmed after an alarm has been reported (*Opening Report Only After Alarm Report*). Note that Subscriber Identification Numbers and Opening Codes must be entered for either opening report.

Program *Opening Report Only After Alarm Report* to report only when disarming after an alarm report. This feature may be used by the central station to verify that the subscriber has responded and disarmed the panel. If *Opening Report Only After Alarm Report* is selected, also select *Opening Report* for each user.

Panic Zone

Keypad Aux Panic

Keypad (Police) Panic

Keypad Fire Panic See *Fire*

The *Panic Zone* is always a 24-Hour Zone. Each keypad is individually selectable for keypad panics (see *Keypad Features*). If *Keypad Panic* is programmed for a keypad, police panic is activated by simultaneously pressing the [P] and [*] Buttons. If *Keypad Aux.* is programmed, pressing [A] and [*] Buttons simultaneously will trip an auxiliary emergency alarm. If *Keypad Fire* is programmed, pressing [F] and [*] at the same time will activate fire panic.

Power-Up Delay

If programmed, power-up will be delayed for 5 minutes to

allow devices such as PIRs sufficient time to stabilize (warm up). This will prevent false alarms when ac power is restored after a lengthy power outage (and the backup battery is discharged).

Pre-Alarm Warning

Programmable by zone, this feature will cause an alarm condition to sound only at the keypad for the duration of the programmed abort delay (see *Abort Delay; Time Selection*). After the abort delay has elapsed, the alarm output will activate and a report will be initiated. **Note:** If no *Abort Delay* time is programmed, the *Pre-Alarm Warning* duration will be 10 seconds.

Pre-Dial Delay

A *Pre-Dial Delay* may be used whenever a delay is required before dialing. It may be required when programming *Dial-Tone Detection*, which causes the communicator to wait before it attempts to detect a dial tone (see *Dial-Tone Detection*). Certain telephone exchanges send a nonstandard dial tone that the communicator may not be able to detect. With these nonstandard exchanges, it is possible to program *Pre-Dial Delay* rather than *Dial-Tone Detection*. This will cause the communicator to wait for a predetermined period of time before dialing rather than look for a nonstandard dial tone.

Contact the telephone-equipment supplier to find out how long a delay is required before dialing. Select *Pre-Dial Delay* by programming one "D" for each 4-second delay required immediately before the telephone number. **Note:** In UL installations, do not program more than one "D" before the telephone number.

See *Backup Report on Telco 2; Report Telco 3 (Double or Split Reporting)*. Also see *Access Number for Outside Line; Telephone Numbers*.

Priority Area Arming

Prevents area arming if one or more other *Priority Areas* have not yet been armed. **Note:** If multiple *Priority Areas* are programmed, all must be armed before the *Arming Area* can be armed.

Priority Zone (Required for all zones in UL installations.)

A zone that will prevent arming if in trouble. If an attempt is made to arm, the sounder will come on and "ZONES NOT NORMAL / CAN'T ARM" will be displayed for 4 seconds. The keypad may be reset by simply pressing the [ON/OFF] Button. The problem on a *Priority Zone* must be corrected before the panel can be armed.

Any zone may be selected as a *Priority Zone*. A zone in trouble that is neither a *Priority Zone* nor an *Auto-Bypass Zone* will cause an alarm on arming.

Priority Zone with Bypass

A *Priority Zone* that will permit arming if the priority condition is bypassed. If the system is so programmed, the zone will auto-bypass and (optional) the condition will be reported to a central station.

As above, if an attempt is made to arm, the sounder will come on and "ZONES NOT NORMAL / CAN'T ARM" will be displayed. To reset the keypad, press the [ON/OFF] Button; the display will read "ZONE FAULTS". To arm the panel, press the [RESET] Button, then enter the User Code.

Any zone not selected as a *Priority Zone* may be programmed as a *Priority Zone with Bypass*.

Pulse Burglary Relay See *Alarm Outputs*

Receiver Format

The communicator can be programmed to transmit to any standard central-station receiver. A receiver format must be entered for each telephone number used, but a different format may be assigned to each.

Refer to *Backup Report on Telco 2* and *Report Telco 3* to determine whether or not Telephones 2 and/or 3 will be programmed. Call the central station for each telephone number used to confirm the type of receiver in use. Select the receiver format entry for each telephone number from the following table.

ENTRY	RECEIVER FORMAT	DATA FREQ. (HZ)	DUTY CYCLE (ON/OFF)	INTER-DIGIT TIME
(blank)	Ademco, Silent Knight Slow	1900	60/40mS	600mS
1	Sescoa, Vertex, DCI, Franklin Fast	1800	30/20	800
2	Radionics Fast	1850	13/12	400
3	Silent Knight Fast	1900	40/30	560
4	Radionics, DCI, Franklin Slow	1800	60/40	600
5	Universal Hi-Speed	1850	30/20	350
8	Radionics BFSK	Modem formats		
9	4/3/1*			
A	Radionics Modem 2*			
B	SIA*			
C	Point ID*			
D	Express (TouchTone 4/2 format)			

*These formats do not use programmable codes, but Event ID Codes to identify the type of zone as follows:

- 1 - Fire
- 2 - Panic
- 3 - Burglary
- 4 - Holdup
- 5 - Fire Supervision
- 6 - Fire Waterflow
- 7 - Gas Alarm
- 8 - Heat Alarm
- 9 - Sprinkler Alarm
- A - Medical Alarm
- B - Auxiliary Alarm

Relay Follows Zone

Remote Relays can be programmed to follow an open or shorted zone. Program *Activate On* with a "5" to follow an open zone, or a "6" to follow a shorted zone. If values are entered in *Time* locations, the relay will time out after the programmed time.

Relay Outputs See *Alarm Outputs*

Remote Relay Control

Besides the three relays provided on the motherboard, up to 96 additional relays can be controlled from the keypad through the use of RM3008 Relay Modules. The RM3008 is designed for external remote mounting. Each contains 8 relays. Twelve units will provide a total of 96 relays.

* For each relay, program four 2-nibble address locations as detailed in the MA3900 Programming Manual (WI777).

1st Location (XXX1): Program the areas having the ability to shut off the relay. Program Areas 5–8 in the left nibble; Areas 1–4 in the right nibble.

2nd Location (XXX2): Program relay timeout. The left nibble has a time factor of 16; the right a time factor of 1 (also see *Time Selection*). If timeout units are in minutes (see **4th Location**), maximum programmable time is 4¼ hours; if timeout units are in seconds, 4¼ minutes. **Note:** Program a minimum timeout of 3 seconds; if locations are left blank, the relay will not time out.

3rd Location (XXX3): Enter an Event ID Code. A list of Event ID Codes is provided in the Programming Manual.

4th Location (XXX4): Left nibble, program (a) *Zone Type* and (b) *Timeout Units* as follows.

(a) Select *Zone Type* (Leave blank for Burglary Zone):

"1" = Fire; "4" = Day Zone.

(b) If relay timeout will be in seconds, add "8" to *Zone Type* (a) above. Otherwise, relay timeout will be in minutes.

4th Location (XXX4): Right nibble, program *type of activation* as follows:

"1" = Alarm; "2" = Restore; "3" = Trouble; "4" = Trouble Restore; "5" = Follow Open Zones; "6" Follow Shorted Zones. (Leave blank if relay is not used.)

Report Telco 1

Report Telco 3 (Double or Split Reporting)

Alarms, alarm restores, troubles and trouble restores may be selected individually for each zone. Violation of a zone selected to report will communicate the code(s) selected for that zone to the central station.

Normally, *Report Telco 1* is used to report to the central station. *Report Telco 3* is used when certain zones will report to a different receiver (split reporting); *Report Telco 1* and *Report Telco 3* are both used on the same zone to report to two receivers successively (Double Reporting). (Double Reporting requires a successful report to Telco 1 before reporting to Telco 3.) Also see *Backup Report on Telco 2*.

Reset Day Zone with Arm/Disarm Only See *Day Zone*

Reset Relay See *Alarm Outputs*

Selective Bypass

Disable Code Entry for Easy Bypass (Not for UL installations.)

Any or all zones (1–96) programmed for *Selective Bypass* may be removed from the system, but each must be removed separately. Refer to *BYPASSING ZONES* in Section 3 for operation.

Security Bypass, recommended for commercial applications, requires entry of a valid user code.

Easy Bypass, recommended for residential applications, is selected by programming *Disable Code Entry for Easy Bypass*; this will permit bypassing/unbypassing zones without the need of entering a code (see *Easy Bypass* in Section 3). Do not program this feature in high-security applications.

When one or more zones is bypassed, the "BYPASS" reminder on the RP3005LCD keypad will display.

Sensor Watch

Program for any zone containing a PIR or dual-technol-

ogy sensor, floor mats, door contacts, or other device where some activity is expected. This feature supervises the sensor by verifying that the zone activates before the PIR timer runs out. If no trip is detected within the programmed *Sensor-Watch* time, a system trouble will result and "SENSOR FAILURE" will be displayed at the keypad, followed by the zone number(s). Select the *RESET SENSOR MSG* function to reset this system trouble.

Program the Sensor-Watch PIR timer in Location 4088. Select a value in accordance with the anticipated activity within the coverage area while disarmed. In calculating the Sensor-Watch time, note that only the disarmed hours (the time between armed periods) are added. In moderate traffic areas, a Sensor-Watch time of perhaps 1 hour may be appropriate, whereas in remote areas, a time of 8 hours or more may be in order. Supervision time should be calculated for the supervised zone with the least amount of traffic. Up to 255 hours may be programmed (see *Time Selection*).

Single-Digit Format See *Data Format*

Smoke Detectors

Connect smoke detectors as shown in the following diagrams. The normally-closed contacts of the Reset Relay are used to reset the smoke detectors.

Two-Wire Smoke Detectors. Two-wire smoke detectors may only be used only on Zones 1–8. Up to 10 compatible 2-wire smoke detectors may be wired to each zone. In Residential applications, program Pulse Burg Output. Program *Disable Fire Reset* in the applicable area(s).

Zones 7 and 8. Most installations will require no more than two zones for 2-wire smoke detectors. Zones 7 and 8 have

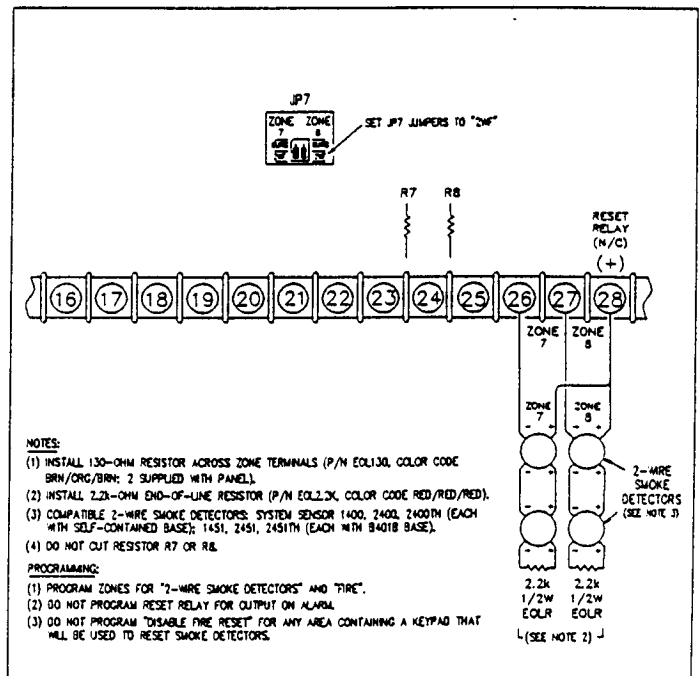

Connecting 2-wire smoke detectors to Zones 7 & 8.

been designed so they can be easily configured as 2-wire smoke detector zones by means of jumpers (JP7) located above Terminal 21.

1. Program Zones 7 and/or 8 for 2-Wire Smoke Detectors and Fire.

2. If Zone 7 is selected as a 2-Wire Fire Zone, move the

left jumper on JP7 from the top two pins (BURG) to the bottom two pins (2WF).

3. Similarly, if Zone 8 is selected as a 2-Wire Fire Zone, move the right jumper on JP7 from the top two pins (BURG) to the bottom two pins (2WF).

4. Connect 2-wire smoke detectors to Zones 7 and/or 8 as shown below.

Zones 1-6. Where more than two 2-wire smoke detector zones are required, select any of Zones 1-6 for 2-wire fire as follows:

1. Program the selected zone(s) (1-6) for 2-Wire Smoke Detectors and Fire.

2. Cut out the 2700Ω resistor (color code: red/violet/red) associated with the selected zone(s). See following table.

ZONE	RESISTOR	LOCATION ON BOARD
1	R1	ABOVE TERMINAL 18
2	R2	ABOVE TERMINAL 18/19
3	R3	ABOVE TERMINAL 19
4	R4	ABOVE TERMINAL 20
5	R5	ABOVE TERMINAL 22
6	R6	ABOVE TERMINAL 23

3. Install a 130Ω resistor (Napco Part No. EOL130; color code: brown/orange/ brown), 3 watts, across the two terminals of each selected zone.

4. Wire the positive (+) terminal of the smoke detector to Terminal 28. Wire the negative (-) terminal of the smoke detector to the positive terminal (+) of the zone.

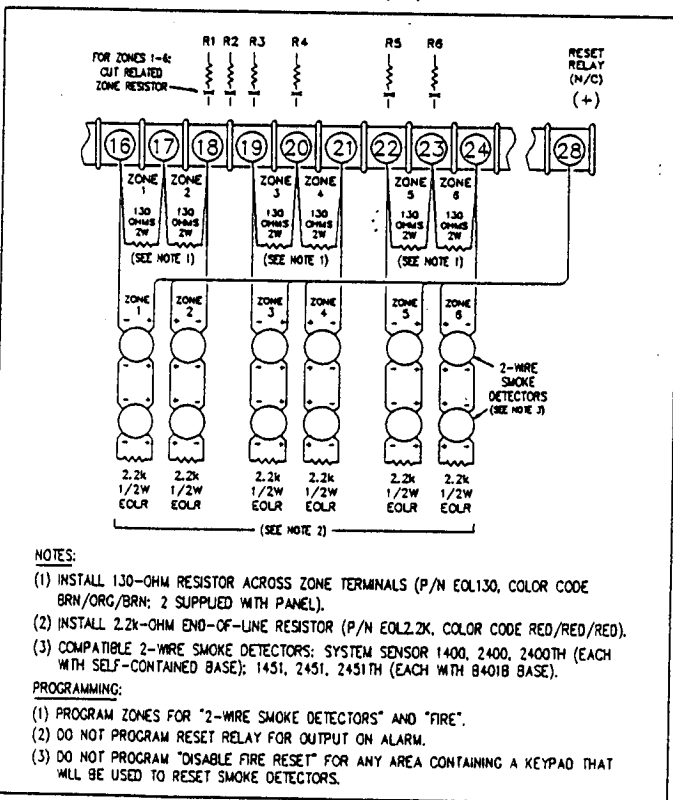

Connecting 2-wire smoke detectors to Zones 1-6.

Four-Wire Smokes. If installing 4-wire smokes, subtract smoke-detector alarm current from available standby cur-

rent. See *COMPATIBLE UL-LISTED DEVICES*.

Wire 4-wire smokes as shown in the following wiring diagram. Program each zone for *Fire*. Also program zones for *Pulse Burglary Relay*, and *Disable Fire Reset* in the applicable area(s) (System Options). If they are of the self-resetting type, 4-wire smokes may be powered from Terminals 13 and 14 (AUX. PWR.) instead of Terminal 28 and 29, thus freeing the Reset Relay for other uses.

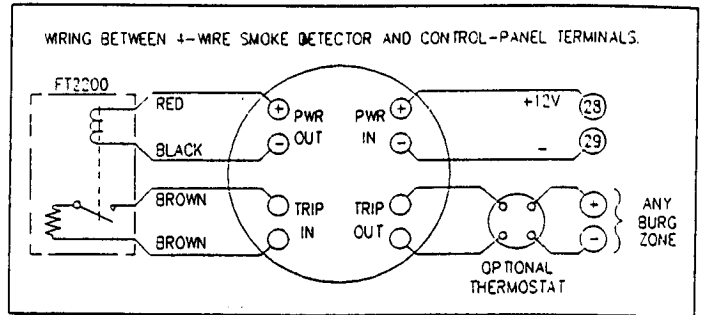

Wiring diagram, four-wire smoke detectors.

Split Reporting See *Report Telco 3*

Start Exit Delay After Ringback

When a closing report is successfully received, the central station will acknowledge by returning a kissoff signal. When the kissoff is received by the communicator, a 2-second ringback tone will sound at the panel. *Start Exit Delay After Ringback* will cause the exit delay to start after the ringback sounds.

If this option is chosen and no ringback sounds shortly after the control panel is armed, exit delay will not start and opening the exit/entry door will cause an instant alarm. To manually start the exit delay, select the *START EXIT TIME* function, then press the [ON/OFF] Button to execute.

Note: (1) If this feature is selected, Exit/Entry Follower Zones will not arm until either a ringback sounds or the *START EXIT TIME* function is used. (2) If communicator, telephone lines or central-station receiver is out of service, the system will be armed without communication capability.

Status Report See *Closing Report*

Subscriber Identification Numbers

If reporting openings and/or closings, program *Subscriber Opening/Closing Identification Numbers* for each area for each telephone number used. If reporting events, program *Subscriber ID Numbers* for each area for each telephone number used. Subscriber ID numbers must be programmed for each area and telephone number, even if all are the same. Start with the left-most location.

Sum Check See *Data Format*

Suppress "BYPASS" Reminder When Armed (Must be enabled in all UL systems)

Program to inhibit the LCD "BYPASS" display while armed.

Swinger Shutdown (Do not program for UL Installations.)

Program for zones with *Auto-Reset* to only reset twice (3 alarms) until rearmed to prevent "swingers" (intermittents) from causing repeated false alarms. See *Auto-Reset*. The *Swinger-Shutdown* feature is programmable by zone, but is not applicable to Ambush.

System Trouble Reports (Global and Area)

Global system troubles may be programmed to report to any telephone number and/or activate the Burglary Output. *Area* system troubles may be programmed to report to any telephone number and/or activate any output. Also program *Subscriber ID Numbers*, *Telephone Numbers*, and *Report Codes* for each system trouble.

Tamper EZM Tamper Keypad Tamper RF Tamper

Removing the cover of an expansion zone module will cause the sounder to pulse and the "SYS TBL" reminder to flash. The keypad will display "TAMPER EZM XX", where "XX" denotes the module number. Press the [RESET] Button to silence the sounder ("SYSTEM READY" will display). Correct the problem, then select *RESET SYSTEM TBL* to manually reset the system trouble display.

Removing a keypad from the wall will cause a similar system trouble indication. The keypad will display "TAMPER KEYPAD XX", where "XX" denotes the keypad number. Press the [RESET] Button to silence the sounder ("SYSTEM READY" will display). To manually reset the system trouble, correct the problem then select *RESET SYSTEM TBL*.

Note: If either of the tamper conditions is not corrected within 5 minutes, the system trouble will again display at the keypad.

A Tamper condition can be programmed to activate the burglary output and/or report using its associated system Report Code.

In wireless installations, when displaying rf transmitter status, a "Tamper" indication denotes that the transmitter case is open.

Telco Fail See *Enable Line-Fault Test*

Telco Line Test Delay See *Enable Line-Fault Test; Time Selection*.

Telephone Numbers

To report to a central station, *Telephone Number 1* must be programmed. *Telephone Number 2* is programmed for Backup Reporting; *Telephone Number 3* is programmed for Double or Split Reporting.

Private telephone systems may require a *Dial-Tone Detection "E"* or *Pre-Dial Delay "D"*, followed by an access number to obtain an outside line. (See *Access Number for Outside Line*.)

It should be noted here that the telephone number need not actually start in the first location shown, and may not end in the last. Extra locations have been provided to allow for one or more prefix digits: a *Pre-Dial Delay "D"* or a *Dial-Tone Detection "E"*. What is important is that the telephone number, with its associated *Pre-Dial Delay*, *Access Number*, and *Dial-Tone Detection*, be wholly contained within that group of locations, and that they be in their proper sequence.

Test Timer

Cancel Next Test Timer Report on Any Report

The test timer schedule is programmed using Napco's PCD3000 Quickloader Software. If *Test Timer* is programmed, an automatic test report will be transmitted to the central station on the scheduled day(s) at the scheduled time. (UL installations require a report at least

every 24 hours.) To report test timer, select *Report Test Timer* and program a report code. Program the *Test Timer* event schedule and reporting time.

In Commercial-Fire applications, the test timer will report abnormal or unrestored conditions. A "NOT NORMAL" condition as displayed at the keypad will result in the following transmitted codes:

- **Pulse Format:** Trouble Code and second digit of Test Timer Code
- **Ademco Point ID:** *Normal*, 602 G00 000; *Not Normal*, 602 G00 001.
- **SIA:** *Normal*, RP 1; *Not Normal*, RP 8.
- **Modem-2:** *Normal*, Code 1 F01; *Not Normal*, Code 1 F09.
- **FBI:** *Normal*, 7F 001; *Not Normal*, 7F 009.
- **BFSK:** Trouble Code and second digit of Test Timer Code.

Note: Commercial-Fire systems are programmable only through Napco's Quickloader software.

If *Cancel Next Test Timer Report on Any Report* is programmed, any report will cause the next test-timer transmission to be aborted, however subsequent test-timer transmissions will report as scheduled. Do not program this feature in UL installations.

Timeout

Specifies the length of time that an alarm, alert, or delay will remain active. *Relay Output 2 Access Control Time*, *Abort-Delay Time*, and *Chime Time* must be programmed, or the feature will not activate. See *Time Selection*.

Time Selection

The following times are programmable:

TIME ⁽¹⁾	UNITS	MAX. PROGRAMMABLE TIME
RESET RELAY	MIN.	UNTIMED ⁽²⁾
AUXILIARY RELAY	MIN.	UNTIMED ⁽²⁾
AUXILIARY RELAY ACCESS CONTROL	SEC.	4 MIN, 15 SEC (255 SEC)
BURGLARY RELAY	MIN.	UNTIMED ⁽¹⁾⁽²⁾
PULSE-BURG RELAY	MIN.	UNTIMED ⁽¹⁾⁽²⁾
FIRE LUG	MIN.	UNTIMED ⁽²⁾
ABORT DELAY	SEC.	4 MIN, 15 SEC (255 SEC) ⁽³⁾
CHIME TIME	SEC.	4 MIN, 15 SEC (255 SEC) ⁽³⁾
AC-FAIL REPORT DELAY	2 MIN.	8 HR, 30 MIN (510 MIN)
EXIT DELAY	SEC.	4 MIN, 15 SEC (255 SEC) ⁽⁴⁾
ENTRY DELAY 1	SEC.	4 MIN, 15 SEC (255 SEC) ⁽⁴⁾
ENTRY DELAY 2	SEC.	4 MIN, 15 SEC (255 SEC) ⁽⁴⁾
TELCO LINE-TEST DLY	SEC.	4 MIN, 15 SEC (255 SEC) ⁽⁶⁾
AUTO ARM REARM DLY	MIN.	4 HR, 15 MIN (255 MIN)
GUARD-TOUR PERIOD	MIN.	4 HR, 15 MIN (255 MIN)
SENSOR-WATCH TIME	DIS-ARMED HOURS	255 HOURS ⁽⁷⁾

NOTES: (1) The output used for Burglary must be at least 4 minutes in Residential UL installations, 15 minutes in Commercial UL installations. (2) If both locations are left blank, this feature will remain active until the system is disarmed. When both locations are programmed "F", maximum time will be 4 hours, 15 minutes (255 minutes). (3) If both locations

are left blank, this feature will not activate (timeout = 0). (4) In UL installations: Maximum Exit Delay = 60 sec; Maximum Entry Delay = 45 sec. (5) Do not program for more than 120 seconds. If using waterflow initiating devices having mechanical delay, UL requires that these locations be left blank to prevent programming additional delay time. (6) If programming locations are left blank, delay will default to 10 sec. (7) Time in units of disarmed hours (accumulated between armed periods).

Any timeout up to those shown in the foregoing table may be programmed. Note that each of the above times is programmed in two locations. The first location has an assigned time factor of 16, the second a time factor of 1.

1st BOX	2nd BOX
tx16	tx1

Time t:	0	1	2	3	4	5	6	7	8	9	10	11	12	13	14	15
Entry:	*	1	2	3	4	5	6	7	8	9	0	B	C	D	E	F

*Blank.

Note: If both programming locations are left blank, refer to the notes in the *Time Selection* table for feature timeout.

To select a time up to 15 seconds, 15 minutes, 15 hours, or 15 days, program the respective entry into the second box only; *do not program the first box*. To select a time greater than 15 seconds, 15 minutes, 15 hours or 15 days, program *both* boxes as follows:

1. For the feature selected, choose an appropriate time in units shown (all seconds, minutes, hours, or days – not minutes and seconds, etc.).

2. Divide the time chosen by 16. Enter the *quotient* in the *1st BOX* and the *remainder* in the *2nd BOX*.

3. Check entries by adding the contents of the *2nd BOX* to 16 times the contents of the *1st BOX*. (Remember that a "zero" entry represents 10.)

Example. Program *Entry Delay 1* for 1½ minutes.

1. *Entry Delay 1* is in units of seconds, thus delay time is 90 seconds.

2. Divide by 16: $90/16 = 5$ (quotient) + 10 (remainder). Enter the *quotient* in the *1st BOX* and the *remainder* in the *2nd BOX*:

1st BOX	2nd BOX
5	0
quotient	remainder ("0" for 10)

3. Check entries (remember, a "0" entry = 10): $(16 \times 5) + 10 = 90$.

TouchTone Dialing Only

TouchTone Dialing with Rotary Backup

Select *TouchTone Dialing Only* if the subscriber has TouchTone service. TouchTone dialing is faster than rotary dialing, but not always as reliable.

For the communicator to use TouchTone on all dial attempts, program *TouchTone Dialing Only*. To use TouchTone on the first attempt with subsequent Rotary dial, program *TouchTone Dialing with Rotary Backup*. *TouchTone Dialing Only* will override *TouchTone Dialing with Rotary Backup* if both are selected. Note that if Backup Reporting is also selected, the communicator will alternate between TouchTone and rotary dial to reach Telephone 1, then Telephone 2. See *Backup Report on Telco 2*.

Tour Station See *Guard Tour*

Transmit "402" Closing Code

Program to send a "402" closing code for *Ademco Point ID* modem format.

Trouble

An abnormal zone condition (a break in a normally-closed loop; a short on a normally-open loop; or either on an end-of-line-resistor supervised loop) when disarmed.

Trouble on a Burglary Zone is automatically displayed at the keypad unless *Disable Auto Status* is programmed. If a Burglary Zone is in trouble, it will go into alarm about 10 seconds after arming. However, if *Auto Bypass* is programmed, the keypad will beep upon arming (does not apply to selective- or group-bypassed zones).

Trouble (open and/or short circuit) on a Day Zone is indicated by a pulsing sounder; display the Day Zone(s) in trouble on the LCD. Keypad indications are reset by the [RESET] Button unless *Reset Day Zone With Arm/Disarm* is selected.

Trouble on a Fire Zone will be indicated by the "FIRE" reminder and the sounder. An open circuit (trouble) will cause a flashing "FIRE" display and a pulsing sounder after a 15-second delay. (A short circuit will cause an alarm condition: steady-on "FIRE" display and pulsing sounder.) The [RESET] Button will silence the sounder. Clear the trouble, then press the [RESET] Button once again. The keypad will reset after a brief delay.

Trouble on Open

Trouble on Short

Trouble on Night Open (Do not program for UL installations)

Trouble on Open will identify an open circuit on a loop as a trouble. *Trouble on Short* will identify a short circuit as a trouble. *Trouble on Night Open*, which will identify an open circuit on a normally-closed zone while armed as a trouble condition (*not an alarm*), is intended for use with a Napco Monitor-Series dual-technology sensor. While there will be no indication at the keypad, any of these trouble conditions can be reported if *Report Trouble* is programmed as well. See *Sensor Watch*.

Trouble/Trouble Restore Telco 1/Telco 3 See *Report Telco 1/Telco 3*

Trouble/Trouble Restore Telco 2 See *Backup Report on Telco 2*

Two-Digit Format See *Data Format*

Two-Wire Smoke Detectors See *Smoke Detectors*

User Codes/Authority Levels/Access Bytes

User Closing and Opening Reports by Telephone Numbers

Enable User Code by Area

Up to 96 six-digit User Codes are programmable, each with its dedicated Authority Level and Access Byte. (The Authority Level comprises an Option Code.) Refer to Programming Manual WI777 for descriptions of levels and options.

If reporting to a central station, program *User Closing and Opening Reports by Telephone Numbers*. In multiple-area systems, program *Enable User Code by Area*.

Watch Mode (by Area) See *Day Zone*

Zone ANDing, Groups 1–8 (Do not program for UL instal-

lations)

Enable Local Alarm on First Zone "AND" Trip (Do not program for UL Installations)

Up to eight groups of at least two zones each can be "AND"ed, wherein the system will go into alarm only if any two zones of the group are tripped within a prescribed time. This feature is designed to afford redundant protection for devices, such as glassbreak detectors, PIRs, etc., that may show a tendency to false under certain conditions. Program each group for any number of Zones 1-96. All zones in any group must be within the same area. Do not mix 24-Hour Zones and non-24-Hour Zones within the same group. Do not include a Panic Zone as part of any group.

Note: Any zone that is bypassed or goes into swinger shutdown will automatically disable *Zone Anding* for the entire group.

If *Enable Local Alarm on First Zone "AND" Trip* is programmed, a trip on any zone of the group will cause an alarm indication at the keypad only; there will be no com-

munication to the central station.

Zone Area 1-Zone Area 8 See *Areas*

Zone Number on Pulse Alarm See *Data Formats: Two-Digit Format*

Zone Type See *Data Formats: Modem Formats*

2-Wire, 4-Wire Smoke Detectors See *Smoke Detectors*

4-Wire Bus Failure See *Bus Failure*

24-Hour Zone

A zone that provides protection at all times, whether or not the system is armed. If programmed for silent alarm (no relays or keypad sounder programmed), neither the green STATUS nor the red ARMED LED will indicate the condition of a 24-Hour Zone. If an audible output is programmed, the keypad will display the alarm condition on the LCD.

Note: Do not program a Day Zone as a 24-Hour Zone.

APPENDIX

STANDBY-BATTERY CALCULATION WORKSHEET

Use the procedure given below to determine the required standby battery capacity in Ampere-Hours (AH).

Note: It is not totally accurate to merely multiply the combined standby current (in Amperes) by the standby time (in Hours) to obtain the battery capacity (in Ampere-Hours), since other factors (control-panel charging capabilities, temperature, battery condition, etc.) affect battery operation. The following calculations will yield the theoretical *minimum* required capacity.

I. STANDBY CURRENT

DEVICE	QTY	STANDBY CURRENT (Amperes)	
		EACH	TOTAL
MA3900	1	x	=
EZM3008	___	x	0.050
RP3005LCD	___	x	=
RP3000LCD ⁽¹⁾	___	x	=
RP3003LCD	___	x	=
RP3003LCD ⁽¹⁾	___	x	=
RB3008 ⁽²⁾	___	x	0.040
_____	___	x	=
_____	___	x	=
_____	___	x	=

TOTAL STANDBY CURRENT → (Box 1) × _____ (Standby Time)⁽³⁾ = AH (Box 2)

⁽¹⁾ Backlighting disabled (cut W1, W2 & W3).

⁽²⁾ Add 0.010A for each energized relay.

⁽³⁾ Standby Time in Hours.

II. ALARM CURRENT

DEVICE	QTY	ALARM CURRENT (Amperes)	
		EACH	TOTAL
TOTAL STANDBY CURRENT (from Box 1, above)			
MA3900 ⁽¹⁾	1	x	=
BELLS:	___	x	=
STROBES:	___	x	=
HORN/STOBES	___	x	=
_____	___	x	=
_____	___	x	=
_____	___	x	=

TOTAL ALARM CURRENT → _____ (Alarm Time)⁽²⁾ = AH (Box 3)

⁽¹⁾ Additional current drawn in alarm.

⁽²⁾ Alarm Time in Hours. *Example:* For a 15-minute alarm timeout, Alarm Time = 15+60 = 0.25.

MINIMUM REQUIRED BATTERY CAPACITY = Box 2 + Box 3 → AH

WIRING LEGEND

INSTRUCTIONS: Should removal of the circuit board be necessary, use this wiring legend to relocate leads to their proper terminals. Enter wire identification number or color

code in WIRE NUMBER column; enter wire function in DESCRIPTION column (optional).

TERMINAL NO.	WIRE NO.	DESCRIPTION
1		
2		
3		
4		
5		
6		
7		
8		
9		
10		
11		
12		
13		
14		
15		
16		
17		
18		
19		
20		
21		
22		
23		
24		
25		
26		
27		
28		
29		
30		
31		
32		
33		

KEYPAD FUNCTION AND PROGRAM MODES

NOTE: (1) FUNCTIONS THAT ARE (A) NOT ACTIVE, (B) NOT PROGRAMMED AND/OR (C) NOT APPLICABLE TO USER'S AUTHORITY LEVEL WILL BE SUPPRESSED AND WILL NOT DISPLAY. (2) DUE TO SPACE CONSTRAINTS, RP3003LCD MESSAGES ARE ABBREVIATED AND FUNCTIONS IDENTIFIED BY (♦) ARE ELIMINATED.

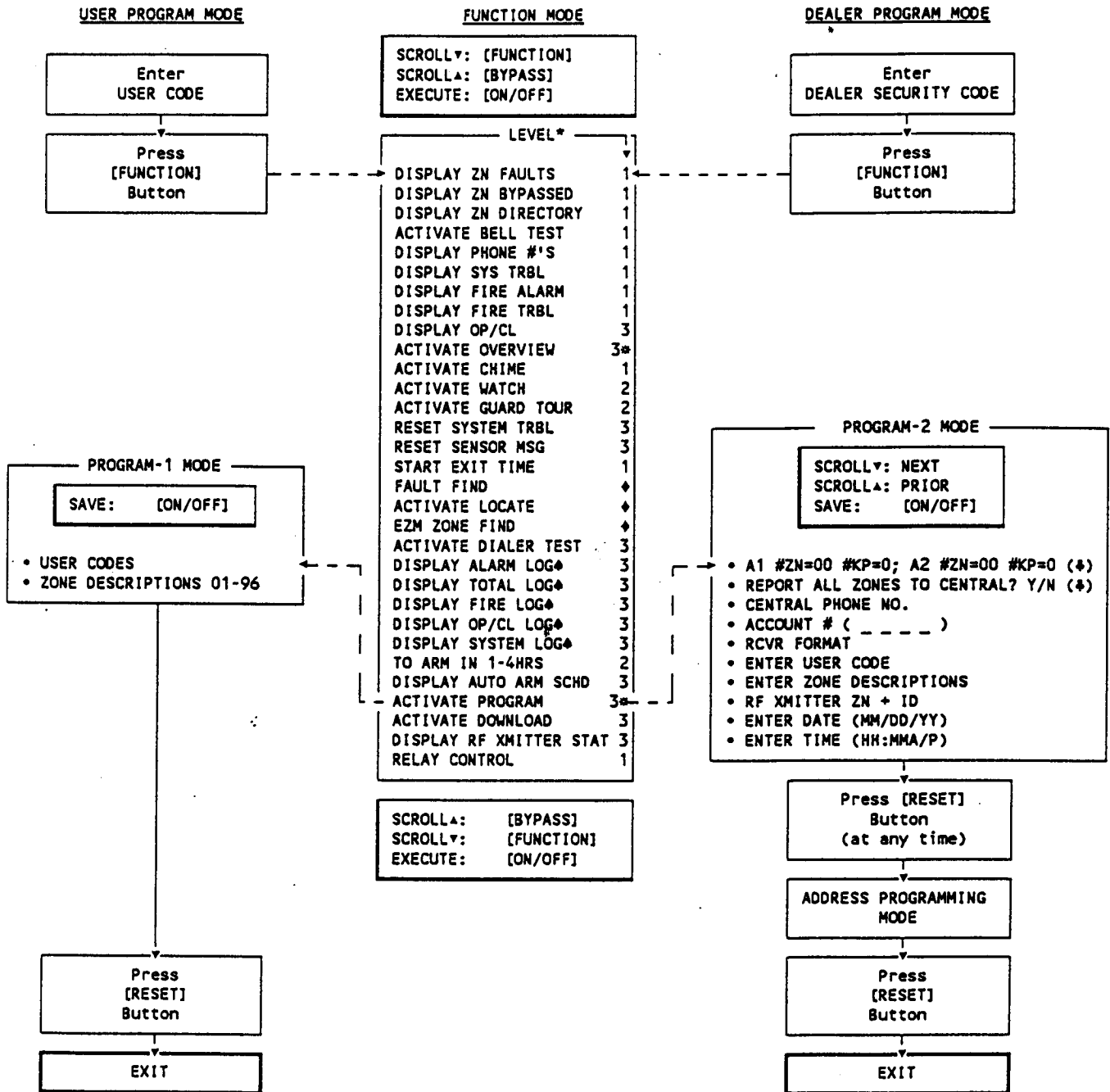

*MINIMUM LEVEL REQUIRED TO ACCESS FUNCTION.
 *LEVEL 3 CODE WITH APPROPRIATE OPTION.
 ♦REQUIRES DEALER CODE.
 ♦NOT AVAILABLE IN RP3003LCD KEYPADS.
 ♦INITIAL CONFIGURATION ONLY; SUPPRESSED THEREAFTER.

KEYPAD CONFIGURATION MODE, FUNCTIONAL DIAGRAM

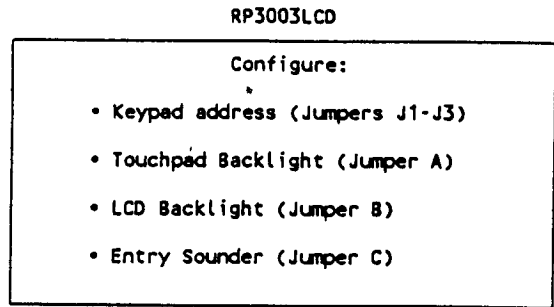
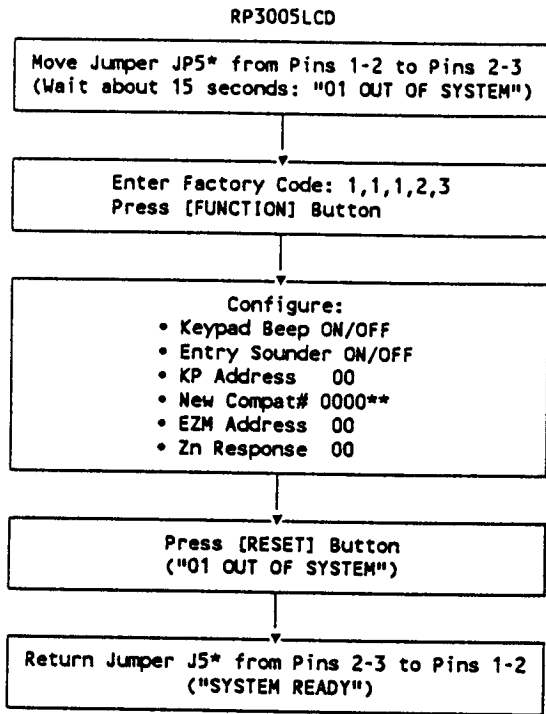

*JP5 is located at the top-right corner of the circuit board.

**If a Compatibility Number other than "0000" is programmed, "Old Compat. # xxxx" is displayed.

WIRING DIAGRAM

MAGNUM ALERT 3900 SERIES NAPCO SECURITY SYSTEMS, INC. AMITYVILLE, N.Y. 11701

WIRING DIAGRAM

(REFER TO OPERATION AND INSTALLATION INSTRUCTIONS W1742)

This equipment should be installed in accordance with the National Fire Protection Association's Standard 74 (National Fire Protection Association Batterymarch Park, Quincy, MA 02269) and local codes. Information describing proper installation, operation, testing, maintenance, evacuation planning, and repair service is to be provided with this equipment.

POWER UP SEQUENCE
1.) CONNECT AC POWER
2.) INSTALL STANDBY BATTERY

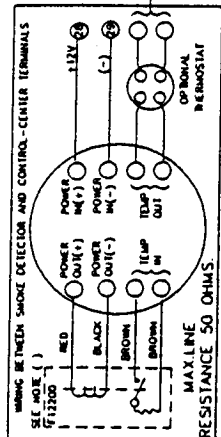

TRANSFORMER	BATTERY	STANDBY CURRENT	BELL CURRENT	SEE NOTE
HOUSEHOLD BURGLARY/FIRE, COMMERCIAL BURGLARY (4 HOUR STANDBY)	RBAT1	.55 AMP	.85 AMP	(2) (3)
HOUSEHOLD BURGLARY/FIRE, COMMERCIAL BURGLARY (4 HOUR STANDBY)	RBAT1	.55 AMP	1.20 AMP	(2) (3)
IRF14	RBAT1B	.9 AMP	1.1 AMP	(2) (3)

UL GRADES FOR THE MA3000
BURGLARY
LOCAL - GRADE A
POLICE STATION - CONNECT BASIC LINE SECURITY - GRADE A
CENTRAL STATION - GRADE C, B OR A
HOUSEHOLD BURGLARY/FIRE, COMMERCIAL BURGLARY - GRADE A
HOUSEHOLD BURGLARY/FIRE, COMMERCIAL BURGLARY - GRADE A
REFER TO WIRE FOR INSTALLATION REQUIREMENTS

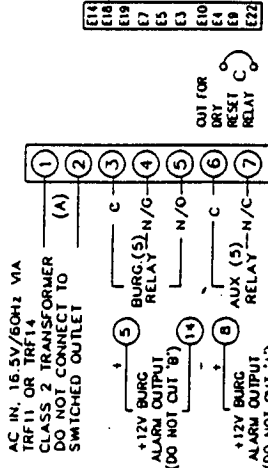
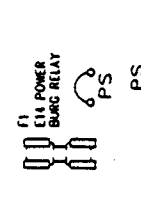

COLD WATER GROUND CONNECTION
USE ONLY COLD-WATER PIPE OR BURIED GROUND ROD. USE AT LEAST #16 AWG WIRE

INITIATING CIRCUITS RATED AT 12 VOLTS, 5mA.

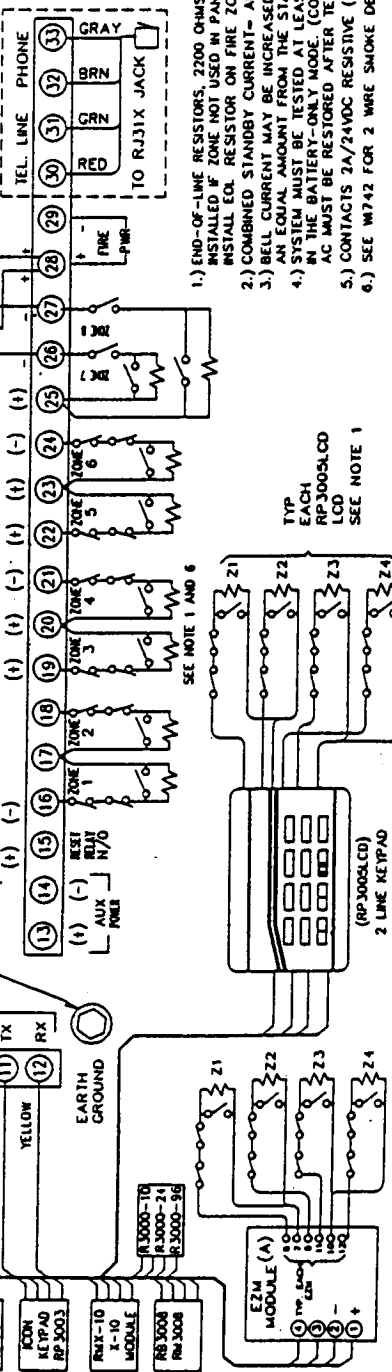

- 1.) END-OF-LINE RESISTORS, 2200 OHMS, RED, RED, RED, 5X 1/2W. (EOL2.2K) ALSO INSTALLED IF ZONE NOT USED IN PANEL OR E2M. (INCLUDING FIRE AND PANIC). DO NOT INSTALL EOL RESISTOR ON FIRE ZONE IF USING FT2200 EOL RELAY.
- 2.) COMBINED STANDBY CURRENT - AUX POWER + REMOTE POWER + RESET RELAY. BELL CURRENT MAY BE INCREASED TO THE 1.2 AMP MAXIMUM BY SUBTRACTING AN EQUAL AMOUNT FROM THE STANDBY CURRENT.
- 3.) SYSTEM MUST BE TESTED AT LEAST ONCE A WEEK IN THE AC/BATTERY MODE AND IN THE BATTERY-ONLY MODE. (CONTACT CENTRAL STATION PRIOR TO TESTING)
- 4.) AC MUST BE RESTORED AFTER TEST.
- 5.) CONTACTS 2A/2AVDC RESISTIVE (CUT JUMPER FOR DRY CONTACT)
- 6.) SEE W1742 FOR 2 WIRE SMOKE DETECTOR WIRING.

LA1234A

NAPCO LIMITED WARRANTY

NAPCO SECURITY SYSTEMS, INC. (NAPCO) warrants its products to be free from manufacturing defects in materials and workmanship for thirty-six months following the date of manufacture. NAPCO will, within said period, at its option, repair or replace any product failing to operate correctly without charge to the original purchaser or user.

This warranty shall not apply to any equipment, or any part thereof, which has been repaired by others, improperly installed, improperly used, abused, altered, damaged, subjected to acts of God, or on which any serial numbers have been altered, defaced or removed. Seller will not be responsible for any dismantling or reinstallation charges.

In case of defect, contact the security professional who installed and maintains your security system. NAPCO shall have no obligation under this warranty, or otherwise, if the product has been repaired by others, improperly installed, improperly used, abused, altered, damaged, subjected to accident, nuisance, flood, fire or acts of God, or on which any serial numbers have been altered, defaced or removed. NAPCO will not be responsible for any dismantling, reassembly or reinstallation charges.

In order to exercise the warranty, the product must be returned by the security professional, shipping costs prepaid and insured to NAPCO. After repair or replacement, NAPCO assumes the cost of returning products under warranty.

There are no warranties, express or implied, which extend beyond the description on the face hereof. There is no express or implied warranty of merchantability or a warranty of fitness for a particular purpose. Additionally, this warranty is in lieu of all other obligations or liabilities on the part of NAPCO.

Any action for breach of warranty, including but not limited to any implied warranty of merchantability, must be brought within the six months following the end of the warranty period. In no case shall NAPCO be liable to anyone for any consequential or incidental damages for breach of this or any other warranty, express or implied, even if the loss or damage is caused by the seller's own negligence or fault.

This warranty contains the entire warranty. It is the sole warranty and any prior agreements or representations, whether oral or written, are either merged herein or are expressly cancelled. NAPCO neither assumes, nor authorizes any other person purporting to act on its behalf to modify, to change, or to assume for it, any other warranty or liability concerning its products.

In no event shall NAPCO be liable for an amount in

excess of NAPCO's original selling price of the product, for any loss or damage, whether direct, indirect, incidental, consequential, or otherwise arising out of any failure of the product. Seller's warranty, as hereinabove set forth, shall not be enlarged, diminished or affected by and no obligation or liability shall arise or grow out of Seller's rendering of technical advice or service in connection with Buyer's order of the goods furnished hereunder.

NAPCO RECOMMENDS THAT THE ENTIRE SYSTEM BE COMPLETELY TESTED WEEKLY.

Warning: Despite frequent testing, and due to, but not limited to, any or all of the following; criminal tampering, electrical or communications disruption, it is possible for the system to fail to perform as expected. NAPCO does not represent that the product/system may not be compromised or circumvented; or that the product or system will prevent any personal injury or property loss by burglary, robbery, fire or otherwise; nor that the product or system will in all cases provide adequate warning or protection. A properly installed and maintained alarm may only reduce risk of burglary, robbery, fire or otherwise but it is not insurance or a guarantee that these events will not occur. **CONSEQUENTLY, SELLER SHALL HAVE NO LIABILITY FOR ANY PERSONAL INJURY, PROPERTY DAMAGE, OR OTHER LOSS BASED ON A CLAIM THE PRODUCT FAILED TO GIVE WARNING.** Therefore, the installer should in turn advise the consumer to take any and all precautions for his or her safety including, but not limited to, fleeing the premises and calling police or fire department, in order to mitigate the possibilities of harm and/or damage.

NAPCO is not an insurer of either the property or safety of the user's family or employees, and limits its liability for any loss or damage including incidental or consequential damages to NAPCO's original selling price of the product regardless of the cause of such loss or damage. If the user wishes to protect itself to a greater extent, NAPCO will, at user's sole cost and expense, obtain an insurance policy to protect the user, supplemental to user's own policy, at a premium to be determined by NAPCO's insurer upon written notice from user by Certified Mail, Return Receipt Requested, to NAPCO's home office address, and upon payment of the annual premium cost by user.

Some states do not allow limitations on how long an implied Warranty lasts or do not allow the exclusion or limitation of incidental or consequential damages, or differentiate in their treatment of limitations of liability for ordinary or gross negligence, so the above limitations or exclusions may not apply to you. This Warranty gives you specific legal rights and you may also have other rights which vary from state to state.